

# User Manual Megger MPQ1000 PQ Analyzer



Valley Forge Corporate Center  
2621 Van Buren Avenue  
Norristown, PA 19403-2329  
U.S.A.

610-676-8500

[www.megger.com](http://www.megger.com)



**MPQ1000  
PQ Analyzer**



Copyright© 2016 by Megger. All rights reserved.

The information presented in this manual is believed to be adequate for the intended use of the product. If the product or its individual instruments are used for purposes other than those specified herein, confirmation of their validity and suitability must be obtained from Megger. Refer to the warranty information below. Specifications are subject to change without notice.

## WARRANTY

Products supplied by Megger are warranted against defects in material and workmanship for a period of one year following shipment no other warranty. The warranty is void in the event of abuse (failure to follow recommended operating procedures) or failure by the customer to perform specific maintenance as indicated in this manual.

Valley Forge Corporate Center  
2621 Van Buren Ave  
Norristown, PA 19403-2329

610-676-8500 (Telephone)  
610-676-8610 (Fax)

*[www.megger.com](http://www.megger.com)*

# Table of Contents

1	Introduction .....	1
2	Receiving Information.....	3
3	Overview of MPQ1000.....	5
	Definitions.....	7
	RMS Calculation: .....	10
	Voltage and Current Waveform Data.....	10
	Rapid Voltage Changes: Under-Deviation Assessment and Over-Deviation Assessment: .....	11
	Voltage Unbalance:.....	11
	Current Unbalance: .....	12
	Energy .....	12
	THD Measurement -.....	13
	Mains Signaling Voltage – IEC 61000-3-8.....	13
	IEC Flicker – See IEC 61000-4-15 .....	13
4	MPQ1000 Specifications.....	15
5	Safety .....	17
	Warnings and Safety Precautions.....	17
	Safety Precautions .....	17
6	MPQ1000 Operation.....	19
	Connector Layout / Interconnect .....	19
	Front Panel Keypad Operation.....	21
	Menu Keys .....	21
	Menu Flow Charts.....	21
	DMM Mode.....	24
	Scope Mode .....	27
	Configuring the MPQ Unit.....	29
	Configure Date and Time format.....	30
	Configure unit preferences.....	32
	Importing / Activating a Setup File .....	33
	Uploading a Setup File from the PC .....	34
	Uploading a Setup File from the USB stick .....	34
	Uploading a Setup File from the SD Card .....	36
	Activating the Imported Setup File .....	37
	Renaming a Data or Setup File .....	38
7	Installing the MPQ1000 Analyzer.....	41
	Battery.....	42
	Battery Charging .....	42
	Battery Storage .....	42
	Installation .....	42
	Voltage and Current Connections .....	43

- 8 WIRING DIAGRAMS for Demand Recording ..... 45
  - Floating Wye Neutral Measurement.....57
  - Verify Active Setup File ..... 58
  
- 9 Starting and Stopping a Recording ..... 59
  - Verify the Input Connections ..... 59
  - Starting a Recording..... 60
  
- 10 Downloading Data from the MPQ1000..... 63
  - Transfer data to a PC via SD Card, Ethernet or USB Cable..... 63
  - Transfer data to a USB Stick ..... 63
  
- 11 Viewing Data on the MPQ PQ Analyzer ..... 65
  - Viewing an RMS Chart..... 66
  - Viewing a Unbalance Chart ..... 68
  - Viewing a Power or Energy Chart..... 70
  - Viewing a THD Chart ..... 72
  - Viewing a Frequency Chart ..... 74
  - Viewing a Harmonics / Inter-Harmonics Chart ..... 76
  - Viewing a Flicker Chart..... 78
  - Viewing an Event Chart..... 80
  
- 12 Unit Maintenance ..... 83
  - Battery Replacement..... 83
  - HELP Screen ..... 86
  
- 13 Spare Parts..... 87

# 1

## Introduction

Thank you for your purchase of the Megger MPQ1000 PQ Power Analyzer. Be assured that your unit has been designed with emphasis on reliability, simplicity and ease of use. It will provide you with the information you need to investigate customer power quality complaints and compliance situations, verify billing, and pinpoint locations of high demand and power consumption.

### ***PURPOSE OF THIS MANUAL***

This document is the operator manual for the Megger MPQ1000 PQ Power Analyzer. It provides a description of the operation of the unit as well as installation and operating instructions. Read this manual before installing or using the equipment. Special emphasis should be placed on all safety discussions.

### ***AUDIENCE***

This manual is written for technical personnel who are familiar with the various measurements performed by power analyzers and have a general understanding of their use and operation. Such personnel should also be thoroughly familiar with the hazards associated with the use of this equipment and should have received proper safety training.

If you find any discrepancies in the MPQ1000 or its software or have any comments, please send them to Megger via fax, e-mail or phone.

Megger  
Valley Forge Corporate Center  
2621 Van Buren Avenue  
Norristown, PA, 19403  
Attn: Customer Service

Fax: (214) 331 7397  
e-mail: [june.crossland@megger.com](mailto:june.crossland@megger.com)

Customer service / Technical Support 1-800-723-2861 ext. 3519  
For more information please visit our web site at: [www.megger.com](http://www.megger.com)

**Megger.**



# 2

## Receiving Information

Contents of MPQ1000 Kit:

<b>Qty</b>	<b>Description</b>
1	Power Quality Analyzer
1	SD Card
1	USB Communications cable
1	Ethernet Cable
1	AC Power Adapter
1	Set of Non-fused Voltage Leads
1	Carrying Case
1	USB Stick containing the Megger PQ Software & manual
	Current Clamps sold separately

When your Megger MPQ1000 Kit arrives, check the equipment received against the packaging list to ensure that all materials are present. Notify Megger of any shortages.

Examine the contents for damage received during transit. If any damage is discovered, file a claim with the carrier at once and notify Megger or its nearest authorized sales representative, giving a detailed description of the damage.

**Megger.**

# 3

## Overview of MPQ1000

The Megger MPQ1000 PQ Analyzer is a hand-held, eight-channel analyzer capable of performing functions on four AC/DC voltages and four current inputs.

In addition to the Power Analyzer, your system includes the *Power Quality Metrosoft® for Windows*, a user-friendly, menu driven software package that allows you to program the unit within minutes. This is accomplished by creating a setup on a computer using *Power Quality Software* and uploading it to the Megger MPQ1000 Power Quality Analyzer. Each unit can store up to 90 user-defined setups. Should you need to change setups on site, you may select any of your programmed setups using the Power Analyzer's front panel controls. Your programmed setup files may also be modified using the front panel of the unit. The software package is also used to download recorded Power Analyzer data, perform database searches, create reports and chart for analyzing the data and more.

Some of the Power Analyzer's features include:	
1	24VDC Power Supply Input, 90 to 264 VAC 50/60Hz.
2	Contains rechargeable battery backup
3	SD Memory Card
4	USB Memory Stick Support
5	Color VGA display
6	Simultaneously records power quality and power flow information
7	Measures power for single phase, split phase, and three phase systems using 1, 2, 2-1/2, and 3 element wattmeters
8	Samples at up to 1MHz measuring transients down to 1usec.
9	Perform harmonic analysis through the 50th harmonic
10	Displays real-time values and graphs and records them for downloading to a computer using the PQ Software.
11	True RMS voltage, minimum RMS voltage, and maximum RMS voltage
12	True RMS current, minimum RMS current, and maximum RMS current
13	Watts, per phase pair and total system
14	Vars, per phase pair and total system
15	Voltamps, apparent power per phase and total system
16	True power factor (watts divided by voltamps)
17	Displacement power factor (cosine of the angle between the fundamental of voltage and current)
18	Kilowatt hours, per phase and total system
19	Kilovar hours, per phase and total system

Some of the Power Analyzer's features include:	
20	Kilovoltamp hours, per phase and total system
21	Harmonic direction from source or load
22	Harmonic magnitude and phase shift
23	Up to 1000 out-of-limits events, with time stamp and duration
24	Waveform capture using selectable triggers
25	Frequency Trending
26	IEC Flicker Trending
27	THD Trending
28	TDD Trending
29	Harmonic Trending
30	Inter-Harmonic Trending
31	Imbalance Trending
32	Rapid Voltage Change Measurement
33	Class A Compliance
34	CAT IV Rating
35	Optional GPS

## ***Applications***

The features of the MPQ1000 make the unit very versatile and capable of performing various applications.

Some of the applications the MPQ1000 can perform are listed below.

- Class A Compliance Testing
- EN50160 Testing
- Harmonic Studies
- Rapid Voltage Change Analysis
- Flicker Analysis
- Imbalance Surveys
- Reliability Studies
- Troubleshooting
- DC System Testing

## Definitions

<b>Class A</b>	A class of unit performance that complies with IEC standard 61000-4-30.
<b>Clock Hour Orientation</b>	A setup feature in the PQ software that when selected will delay the start of the recording until the real time clock in the PQ Device reaches a time interval that is a multiple of the selected storage interval. This will keep each interval from having fractional time stamps.
<b>CT Full Scale</b>	The specified maximum RMS current range of the current clamp in use with the PQ Analyzer
<b>Data File</b>	An electronic file that contains the aggregated measurements of the PQ Analyzer.
<b>Default Frequency</b>	The user selectable frequency in the setup file that the PQ Analyzer defaults to if the phase lock loop is lost.
<b>EFT</b>	Extremely Fast Transient - Transients that have rise and fall times in the nanosecond region.
<b>Flicker</b>	An impression of unsteadiness of the visual sensation, induced by a light stimulus with a luminance fluctuates over time.
<b>GPS Time</b>	A time synchronization procedure applied periodically during a recording using a GPS receiver.
<b>Harmonics</b>	A sinusoidal component of a periodic wave or quantity having a frequency that is an integral multiple of the fundamental frequency.
<b>Hysteresis</b>	A user selectable value that sets a buffer between the trigger level that starts a sag or swell event and the trigger level that ends the event. This value is displayed as a percentage of the user programmed limit.
<b>Imbalance</b>	The ratio of the negative sequence component of a voltage or current to the positive sequence component of that voltage or current, typically expressed as a percentage.
<b>Inter-Harmonics</b>	A harmonic component of a periodic quantity that is not an integer multiple of the fundamental frequency that the supply system is operating.
<b>IP51</b>	A measurement of environmental protections that states the ingress of dust is not entirely prevented, but it will not enter in sufficient quantity to interfere with the satisfactory operation of the equipment and dripping water (vertically falling drops) shall have no harmful effect.
<b>Phase Angle</b>	The delay between the zero crossing of the fundamental voltage signal and the fundamental current signal represented in degrees.
<b>Phase Lock Loop</b>	A measurement control system that ensures the same number of samples are used to analyze a given cycle regardless of the cycles period, within the specifications of the unit.

<b>Post-Triggers</b>	A user selectable value in the setup file that defines the number of cycles the unit will record after a cycle has occurred that has exceeded the user programmed event limits.
<b>Power Factor</b>	The ratio of the total power input, in watts, to the total volt-ampere input to the converter.
<b>Pre-Triggers</b>	A user selectable value in the setup file that defines the number of cycles the unit will record before a cycle has occurred that has exceeded the user programmed event limits.
<b>Rapid Voltage Change</b>	A variation of the rms or peak value of a voltage between two consecutive levels that is sustained for a given durations.
<b>Ratio</b>	A user selectable value in the setup file that defines a value that shall be used to multiply the recorded voltage and / or current values. This feature is used when recording secondary values of a PT or a CT and the operator wishes to record and view the primary value.
<b>Response Interval</b>	A user selectable value in the setup file that allows the user to define the aggregation length of each RMS calculation. Programmed in cycles.
<b>RMS Current</b>	The Root Mean Square value of the current, derived from the summation of the square root of the arithmetic mean (average) of the squares of the original current samples.
<b>RMS Voltage</b>	The Root Mean Square value of the voltage, derived from the summation of the square root of the arithmetic mean (average) of the squares of the original voltage samples.
<b>Sag</b>	An instantaneous or momentary decrease in the steady state RMS value.
<b>Sample</b>	The actual discrete instantaneous measurement the MPQ1000 performs 128 times per cycle.
<b>Scheduled Run</b>	A recording mode in the setup file that will allow the user to select a date and time that the MPQ1000 will start recording.
<b>Setup File</b>	An electronic file that contains the measurement configuration that shall be used by the PQ Analyzer during its recording.
<b>Storage Interval</b>	A selection in the MPQ1000 setup file that allows the user to determine how often the unit wakes up from sleep mode and takes measurements.
<b>Sub-cycle</b>	A power quality event in which the duration is less than a cycle.
<b>Swell</b>	An instantaneous or momentary increase in the steady state RMS value.
<b>TDD</b>	Total Demand Distortion is a measurement of the current THD taking into account the average current load on the circuit during the recording interval.
<b>THD</b>	The ratio of the root-mean-square of the harmonic content to the root-mean-square value of the fundamental quantity, expressed as a percent of the fundamental.

<b>Transient</b>	A sudden non-power frequency change in the steady state condition of voltage or current.
<b>Vars</b>	A unit which is the imaginary counterpart of the watt. The relationship between a VAR and a watt in an alternating-current electrical system is determined by the power factor.
<b>Volt Amps</b>	A measurement of apparent power.
<b>Watts</b>	A unit of energy equivalent to one joule per second.
<b>Waveform Capture</b>	A selection in the MPQ1000 setup file that allows the unit to record sample by sample data of each waveform for both Current and Electric Field. A waveform will be captured once every storage interval. Note: This feature must be enabled in order to calculate THD and Harmonics.

## Calculations

### RMS Calculation:

$$V_{rms} = \sum_{n=0}^{256} \sqrt{\frac{V_i^2}{n}}$$

$$I_{rms} = \sum_{n=0}^{256} \sqrt{\frac{I_i^2}{n}}$$

### Voltage and Current Waveform Data

**Waveform Sample = Binary Value \* Slope\*Cal offset**

Calculation of a sliding reference voltage (First-order filter with a 1-min time constant)

$$Usr(n) = 0.9967 \times Usr(n-1) + 0.0033 \times U(10/12)rms$$

*Where:*

**Usr(n)** is the present value of the sliding reference voltage;

**Usr(n-1)** is the previous value of the sliding reference voltage; and

**U(10/12)rms** is the most recent 10/12-cycle r.m.s. value.



## Rapid Voltage Changes: Under-Deviation Assessment and Over-Deviation Assessment:

$$\text{(underdeviation assessment)} \left\{ \begin{array}{l} U_{\text{under}} = 0 \text{ if } U_{\text{r.m.s}} > U_{\text{din}} \\ \text{otherwise} \\ U_{\text{under}} = \left( \frac{U_{\text{din}} - U_{\text{r.m.s}}}{U_{\text{din}}} \right) * 100\% \end{array} \right.$$

$$\text{(overdeviation assessment)} \left\{ \begin{array}{l} U_{\text{over}} = 0 \text{ if } U_{\text{r.m.s}} < U_{\text{din}} \\ \text{otherwise} \\ U_{\text{over}} = \left( \frac{U_{\text{r.m.s}} - U_{\text{din}}}{U_{\text{din}}} \right) * 100\% \end{array} \right.$$

## Voltage Unbalance:

The negative sequence component  $u_2$  is evaluated by the following ratio, expressed as a percentage :

$$u_2 = \frac{\text{negative sequence}}{\text{positive sequence}} * 100 \%$$

For 3-phase systems, this can be written (with  $U_{ij \text{ fund}}$  = phase i to phase j fundamental voltage):

$$u_2 = \sqrt{\frac{1 - \sqrt{3 - 6\beta}}{1 + \sqrt{3 - 6\beta}}} * 100\% \text{ with } \beta = \frac{U_{12 \text{ fund}}^4 + U_{23 \text{ fund}}^4 + U_{31 \text{ fund}}^4}{(U_{12 \text{ fund}}^2 + U_{23 \text{ fund}}^2 + U_{31 \text{ fund}}^2)^2}$$

The zero-sequence  $u_0$  component is evaluated by the magnitude of the following ratio, expressed as a percentage:

## Current Unbalance:

$$AVG = \frac{(I1 + I2 + I3)}{3}$$

$$I1 \text{ Imb} = ABS((I1/AVG)*100)$$

If I1 > 100 then I1 = I1-100

## Power:

Instantaneous Power (W) = V sample \* I sample

Active Power (P) = V\* I \* cos θ

Reactive Power (VAR) = V\* I \* sin θ

Apparent Power (S) (VA) = S = VI

DPF = cos θ

Power Factor = Pf = TPF = P/S

## Energy

KWH = KW / Number of Demand Intervals in an Hour

KVARH = KVAR / Number of Demand Intervals in an Hour

KVAH = KVA / Number of Demand Intervals in an Hour

## THD Measurement -

$$THD = \sqrt{\sum_{h=2}^{h=H} \left( \frac{Q_h}{Q_1} \right)^2}$$

Where:

- Q** represents either current or voltage
  - Q<sub>1</sub>** is the r.m.s. value of the fundamental component
  - h** is the harmonic order
  - Q<sub>h</sub>** is the r.m.s. value of the harmonic component of order *h*
  - H** is 50 for the purpose of the compatibility levels in this standard
- NOTE:** THD takes account of harmonics only.

## Mains Signaling Voltage:

Performed per IEC 61000-3-8

## IEC Flicker:

Performed per IEC 61000-4-15

**Megger.**

# 4

## MPQ1000 Specifications

<b>SPECIFICATIONS REFERENCE</b>	25°C (77°F)
Sampling Rate	1MHz
RMS Sampling Rate	256
RMS Aggregation	1 Cycle
Event Aggregation	1/2 Cycle
<b>VOLTAGE</b>	
Voltage Input Channels	4
Voltage Range	0-1000V AC/DC
Voltage Accuracy	0.1% U <sub>din</sub> over range of 10%-150% of U <sub>din</sub>
Voltage Crest Factor	1.5 Max
<b>CURRENT</b>	
Current Input Channels	4
Current Range	0-6000A (CT Dependent)
Current Accuracy	0.1% of full scale + CT
Current Crest Factor	4.0 Max
<b>FREQUENCY</b>	
Fundamental Frequency	42.5-69Hz
Frequency Response	DC to 50 <sup>th</sup> Harmonic
Frequency Resolution	0.01Hz
Frequency Accuracy	0.01Hz at 60Hz
Transient Response	1μsec
<b>DEMAND</b>	
KW Accuracy	Voltage Accuracy * (Current Accuracy +CT)
KVAR Accuracy	Voltage Accuracy * (Current Accuracy +CT)
KVA Accuracy	Voltage Accuracy * (Current Accuracy +CT)
Phase Angle Error	+/-1 Degree
<b>FEATURES</b>	
Harmonics	DC-50 <sup>th</sup> per IEC 61000-4-7
Flicker	IEC61000-4-15
Unbalance	IEC61000-4-27

Rapid Voltage Change	IEC61000-4-30
Real Time Clock Accuracy	Better than +/-0.005%
<b>POWER SUPPLY / CHARGER</b>	
Input	90-264VAC (47-63Hz), 79VA Max
Output	24VDC
<b>BATTERY</b>	
Battery Type	12VDC NiMH (Use only Megger Battery)
Run Through Time	8 Hours Minimum without CT's
Charge Time	2 Hours
<b>MEMORY</b>	
Memory Type	SD Card
Memory Size	32G Max
USB Memory Stick	Supported
<b>PHYSICAL</b>	
Communications	USB & Ethernet
Display	VGA
Weight	2.27kg (5.0lbs) Max
Size	255(H) x 175(W) x 55(D) Maximum
<b>ENVIRONMENTAL</b>	
Operating Temperature	0°C to 50°C
Storage Temperature	-20°C to 60°C
Humidity	95% NC
IP Rating	51
<b>SAFETY</b>	
Channel to Channel Isolation	Common Neutral
Safety Standard	IEC61010
CAT Rating	IV at 600V (BETA units CAT III at 600)
<b>STANDARDS COMPLIANCE</b>	
IEC Standard	IEC61000-4-30
IEC Flicker	IEC61000-4-15
IEC Unbalance	IEC61000-4-27
IEC Power Frequency	IEC61000-4-28
IEC Harmonics	IEC61000-4-7
Standards Test	EN50160
CE Standard	EN50081-1
CE Standard	EN50082-1

# 5

## Safety

### *Warnings and Safety Precautions*

	<b>WARNING!</b>
<b>Death, serious injury, or fire hazard could result from improper use/installation of this instrument. Read and understand this manual before installing this instrument.</b>	

Installation of this instrument **MUST** be performed in compliance with the National Electric Code and any additional safety requirements applicable to your installation.

Installation, operation and maintenance of this instrument **MUST** be performed by qualified personnel only. The National Electrical Code defines a qualified person as one familiar with the construction and operation of the equipment and the hazards involved.

### *Safety Precautions*

The following safety precautions **MUST** be taken whenever the Power Quality instrument is installed.

- Wear safety glasses and insulated gloves when making connections to power circuits
- Hands, shoes, floor/ground must be dry when making any connection to a power line

These warnings and safety precautions are to be used where appropriate when following instructions in this manual.

	<b>CAUTION!</b>
<b>The equipment could be impaired from improper use. Read the complete manual before use.</b>	



**WARNING!**

The equipment should not be used while its battery door is removed or if there is any visible damage to the case or if the hardware holding the unit together has been loosened.



# 6

## MPQ1000 Operation

The following section describes the operation of the MPQ1000 unit. This section will describe in a step by step manner how to setup, program, install and download data from the MPQ1000.

### ***Connector Layout / Interconnect***

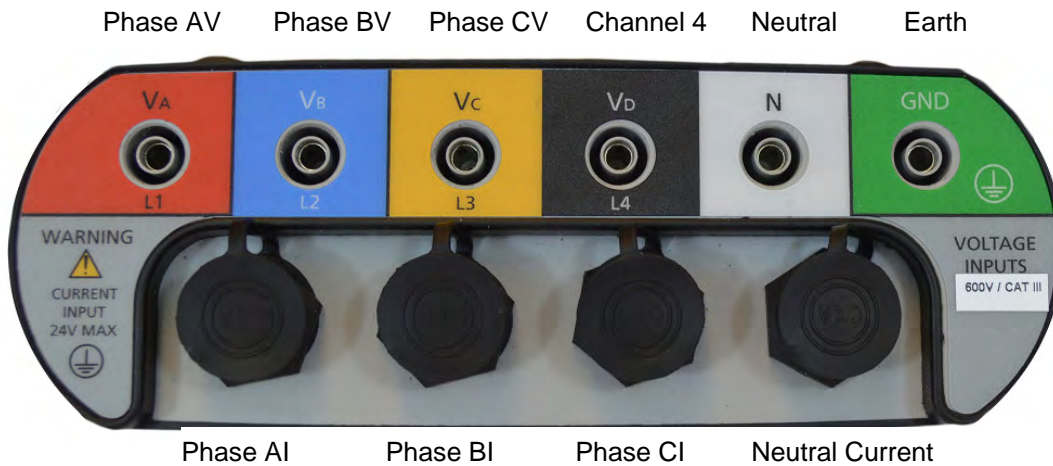

### ***Communication Ports***

(USB Stick, USB Port & Ethernet port) located on side of analyzer.



## ***DC Power Jack***

Located on the back of the analyzer.



## ***SD Card***

Located on the side of the analyzer



---

## ***Front Panel Keypad Operation***



## ***Menu Keys***

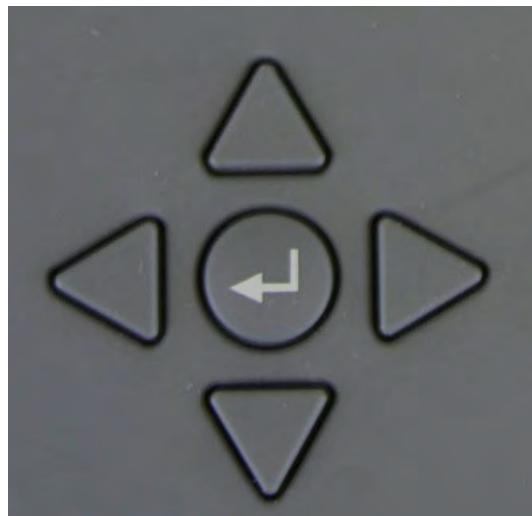

## Menu Flow Charts

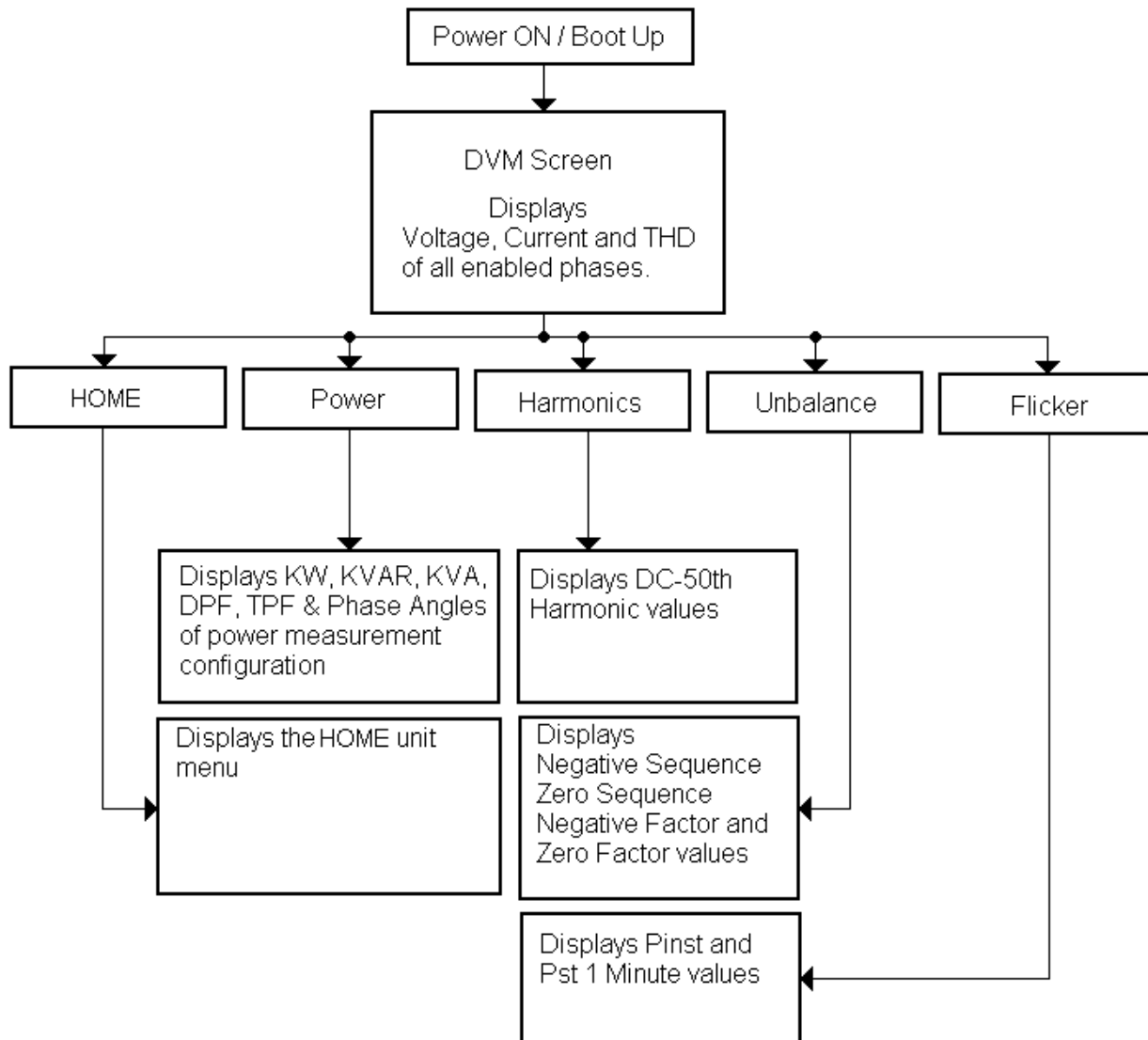

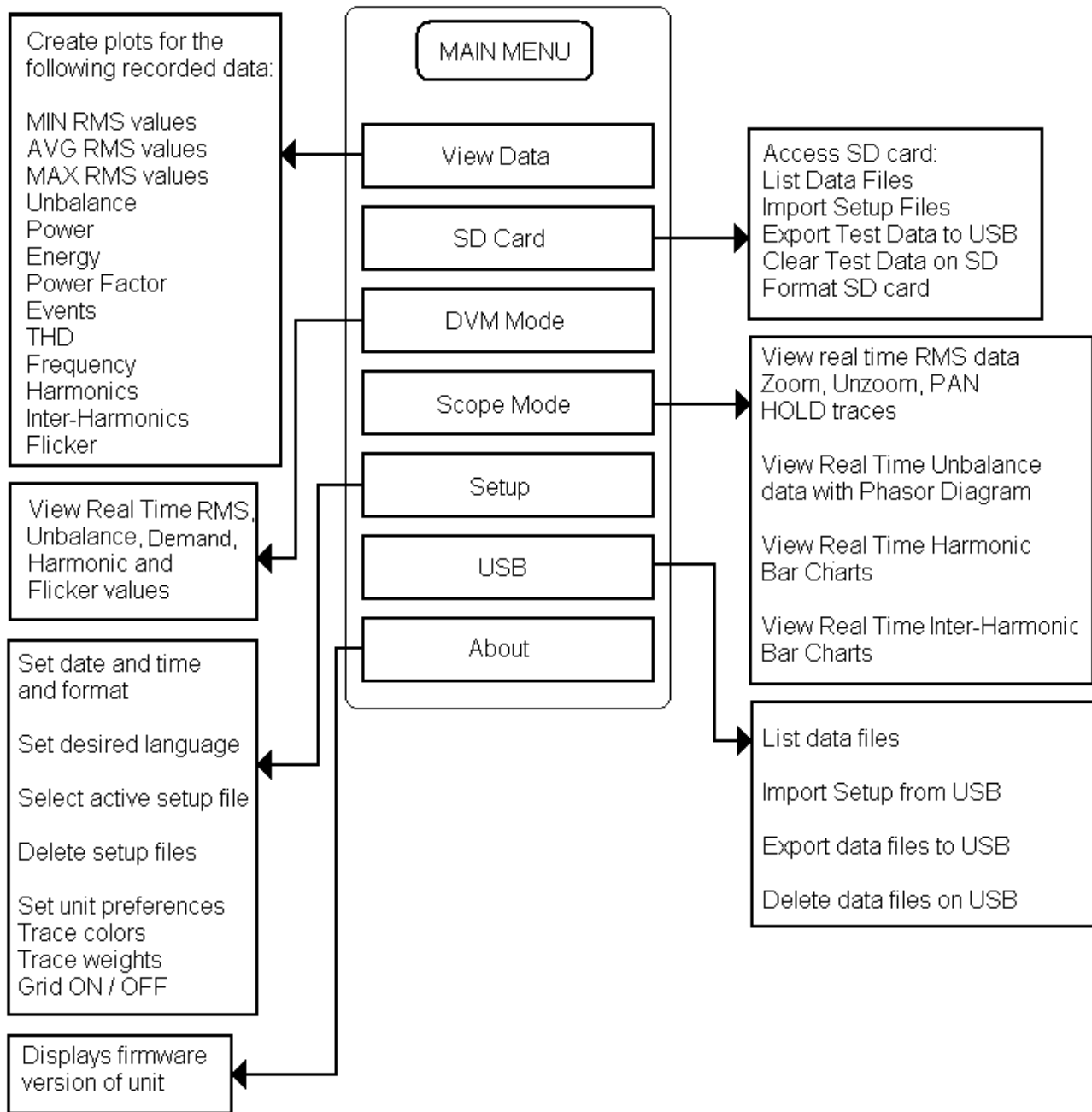

**NOTE:** *Formatting the SD card will NOT erase data or setup files present on the SD card.*

## DMM Mode

The MPQ2000 has a real time multi-meter mode. In this mode the analyzer will display real time voltages, currents, THD, power, phases, unbalance, harmonics and flicker.

The DMM screen will open when the analyzer first powers up.

The DMM screen can also be opened by pressing the DMM short cut key.



The DMM screen consists of 5 different screens.

1. The DMM screen.



DMM MODE 02/10/2016 04:52 PM

	VOLTAGE		CURRENT
	VOLTAGE (V)	THD (%f)	CURRENT (A)
PHASE A	121.76	0.00	873.24
PHASE B	121.81	0.00	978.68
PHASE C	121.76	0.00	743.47
NEUTRAL	0.00	0.00	0.00
GROUND	--	--	0.09

Select function

HOME POWER HARMONICS UNBALANCE

This screen will display *Real Time Voltages, THD and Currents.*

2. The POWER screen.

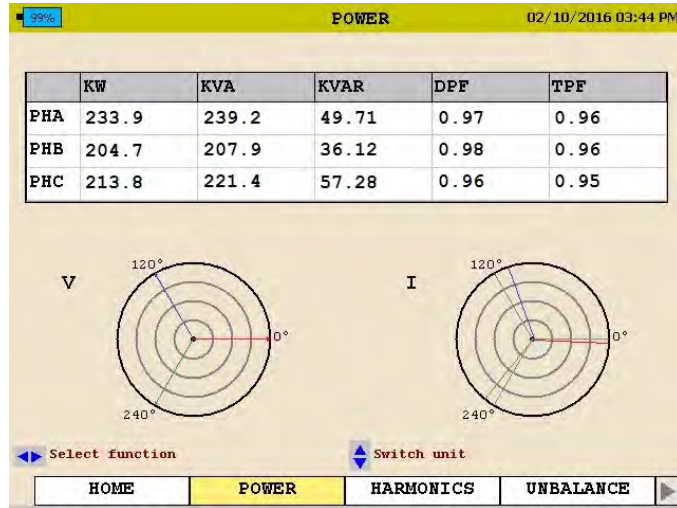

This screen will display *Real Power, Reactive Power, Apparent Power, Displacement Power Factor and True Power Factor*.

3. The UNBALANCE screen.

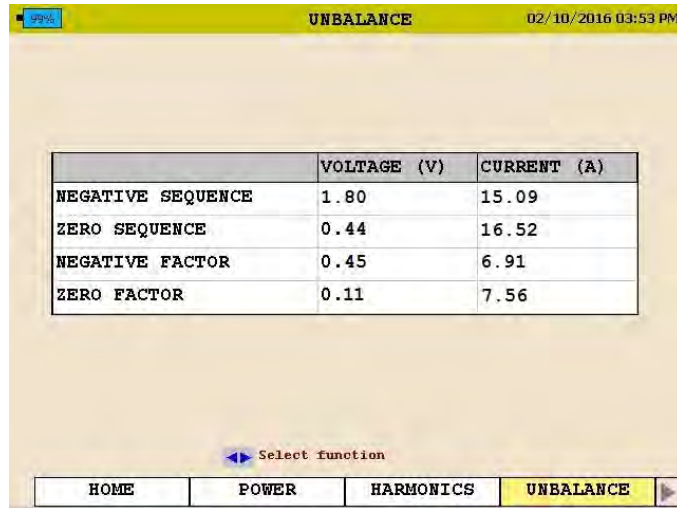

This screen will display the *Negative Sequence Unbalance and The Zero Sequence Unbalance*.

#### 4. The HARMONICS screen.



The screenshot shows the HARMONICS screen with a table of harmonic magnitudes. The table has columns for DC, 1st, 2nd, 3rd, and 4th harmonic orders. The rows represent PHAV %, PHBV %, and PHCV %.

	DC	1st	2nd	3rd	4th
PHAV %	0.00	100.0	0.00	7.52	0.00
PHBV %	0.00	100.0	0.01	5.64	0.00
PHCV %	0.00	100.0	0.00	8.96	0.01

Navigation controls include "Select function" and "Scroll through orders" arrows, and a menu bar with buttons for HOME, POWER, HARMONICS (highlighted), and UNBALANCE.

This screen will display the *Magnitude of the Harmonic Orders*.

Use the ▲UP / ▼DOWN arrows to scroll through the harmonic orders.

#### 5. The FLICKER screen.

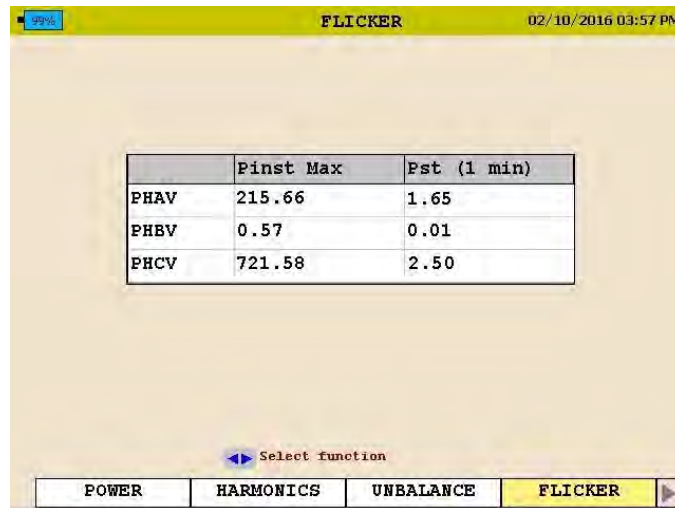

The screenshot shows the FLICKER screen with a table of flicker parameters. The table has columns for Pinst Max and Pst (1 min). The rows represent PHAV, PHBV, and PHCV.

	Pinst Max	Pst (1 min)
PHAV	215.66	1.65
PHBV	0.57	0.01
PHCV	721.58	2.50

Navigation controls include "Select function" arrows and a menu bar with buttons for POWER, HARMONICS, UNBALANCE, and FLICKER (highlighted).

This screen will display the *Instantaneous Flicker* and the *1 Minute Flicker Interval*.

*Note: This screen must be left on for at least 1 minute in order to view the flicker 1 minute interval.*



## Scope Mode

The MPQ2000 has a real time scope mode. In this mode the analyzer will display voltages and current waveforms, unbalance vectors, harmonics, inter-harmonics and harmonic direction.

The SCOPE screen can also be opened by pressing the SCOPE short cut key.



The SCOPE screen consists of 3 different screens.

1. The SCOPE or WAVEFORM Screen.

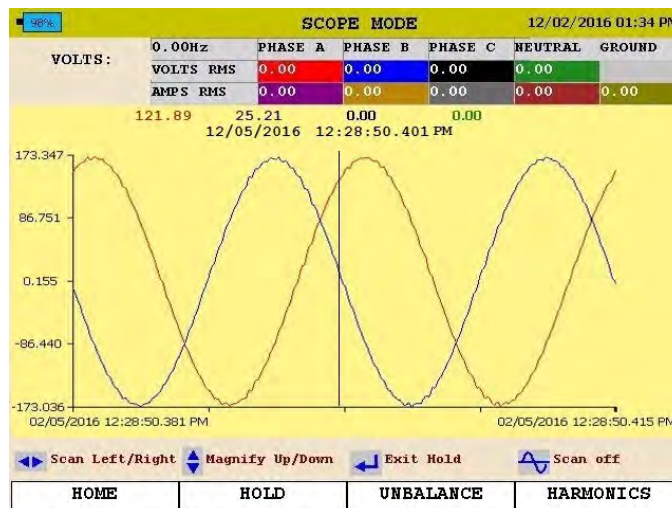

This screen will display *snapshots* of the *Voltage* and *Currents Waveform*. This screen is updated every few seconds.

Use the ▲UP / ▼DOWN arrow keys to scroll through the different phases.

The image can be frozen by arrowing over to the HOLD option and then pressing the ENTER key.

In the HOLD mode the arrows can be used to zoom in and out of the waveform.

By pressing the WAVEFORM key in the HOLD mode a scan line will open. This will allow you to view individual values throughout the waveform.

*NOTE: The bottom of the screen will display the key functions of the analyzer for each screen.*

2. The UNBALANCE screen.



This screen will display *Voltages, Currents, Phase Angles, Negative Sequence Unbalance, Zero Sequence Unbalance and a Vector Diagram of the Angles.*

Use the ▲UP / ▼DOWN arrow keys to toggle between *IEC Unbalance and ANSI Unbalance.*

3. The HARMONICS screen.

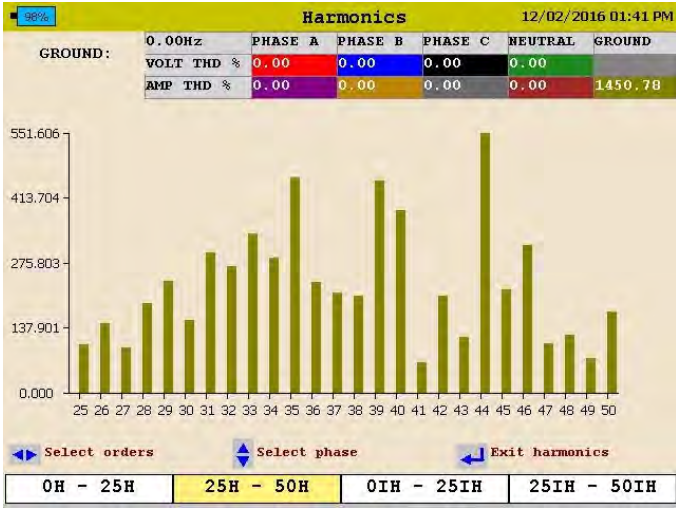

This screen will display *Harmonics and Inter-Harmonics through the 50<sup>th</sup> Order.*

Use the ▲UP / ▼DOWN keys to scroll through the different channels and to view the harmonic direction.

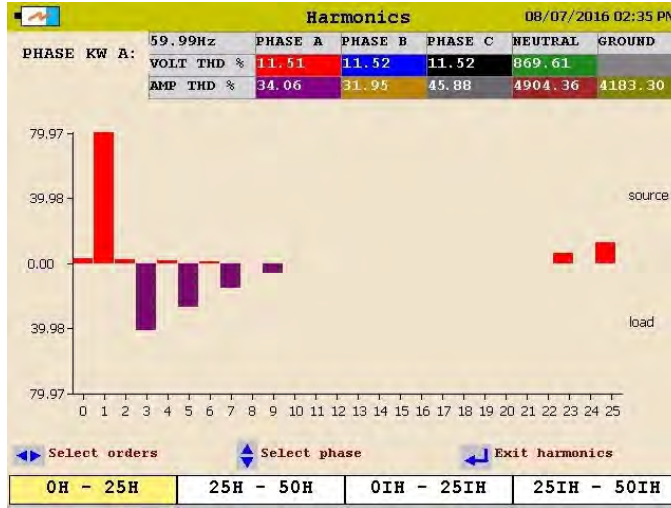

## Configuring the MPQ Unit

Prior to first use the MPQ Unit needs to be configured. This allows the operator to set the date and time format as well as any operator preferences.

*NOTE: If these settings are not made then the date and times in the recordings may be incorrect.*

## Configure Date and Time format

1. From the HOME screen select SETUP then press the ENTER ↵ key.



2. Select DATE/TIME then press the ENTER ↵ key.



3. Use the ▲UP / ▼DOWN & ENTER ↵ keys to scroll down and select the desired date and time formats.

58%

SET DATE AND TIME 02/10/2016 04:51 PM

DATE FORMAT: MM/DD/YYYY

DATE: 02/10/2016

TIME FORMAT: HH:MM:SS AM/PM

TIME: 04:51:53 PM

TIME ZONE: (GMT-05:00) Eastern Time (US & Canada)

ADJUST FOR DAYLIGHT SAVING TIME:

◀ Select function Select date format

BACK

4. Use the ▲UP / ▼DOWN keys to scroll down to TIME ZONE then press the ENTER ↵ key to select.
5. Use the ▲UP / ▼DOWN keys and scroll through the time zones until you find your time zone. Press ENTER ↵ to select the time zone.
6. Use the ▲UP / ▼DOWN keys to scroll down to DAYLIGHT SAVINGS TIME. Press the ENTER ↵ key to toggle between ON and OFF. Select desired mode.
7. When complete, press the BACK button to exit this screen and save the selections.

## Configure unit preferences

1. From the HOME screen select SETUP then press the ENTER ↵ key.



2. Select PREFERENCES then press the ENTER ↵ key.



3. Use the ▲UP / ▼DOWN and ENTER ↵ keys to scroll down and select the desired selections.



From this screen the user can select the following:

1. Change the Voltage and Current Trace colors. (These can be matched to local standards)
2. Click in the SCOPE field to open the drop down menu. This will allow you to select the screen to which the SCOPE shortcut key will default.
3. Click in the DMM field to open the drop down menu. This will allow you to select the screen to which the DMM shortcut key will default.
4. Click in the LINE WEIGHT field to open the drop down menu. From here you can change the line weight of the traces on the charts..
5. Click in the GRID LINE field to enable or disable grid lines on the charts displayed on the unit.
6. Change the Auto shutdown time (in minutes). The analyzer will shutdown after this amount of time providing the analyzer is NOT powered from its AC adapter and the analyzer is NOT recording.

## ***Importing / Activating a Setup File***

A setup file is used to program the unit to perform different types of recording. Multiple setup files can be installed into the unit. These setup files can be activated from the front panel of the unit or using the Megger PQ software.

## ***Uploading a Setup File from the PC***

See the MEGGERPQ Manual.

## ***Uploading a Setup File from the USB stick***





1. Verify the batteries in the unit are fully charged or plug the unit into an AC source.
2. Power up the MPQ-2000 PQ Analyzer and go to the MAIN Menu.
3. Plug the USB stick into the MPQ-2000 type A USB Port.
4. Scroll down to USB on the Main Menu and press the ENTER ↵ key. This will open the USB Memory Screen.



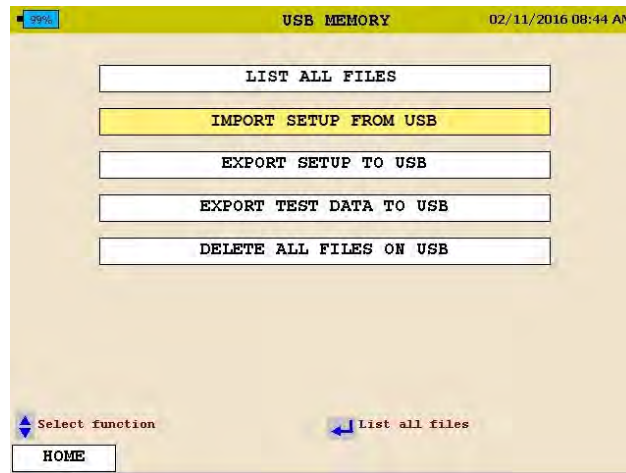

5. Scroll down to IMPORT SETUP FROM USB on the USB Memory screen and press the ENTER  key. This will display the *setup files* on the USB stick.



6. Use the  UP /  DOWN keys to scroll to the desired setup file and press the ENTER  key. This will *import* the setup file to the unit.
7. Press the ENTER  key to close the IMPORT SETUP COMPLETE message.





## Uploading a Setup File from the SD Card

1. Verify the batteries in the unit are fully charged or plug the unit into an AC source.
2. Power up the MPQ1000 PQ Analyzer and go to the MAIN Menu.
3. Plug the SD card into the MPQ1000 SD Card slot.
4. Scroll down to SD Card on the Main Menu and press the ENTER  key. This will open the SD Card Memory Screen.



5. Scroll down to IMPORT on the SD Card screen and press the ENTER  key. This will display the *Setup Files* on the SD Card.



6. Scroll down to the *desired Setup File* and press the ENTER  key. This will import the setup file to the unit.
7. Press the ENTER  key to close the IMPORT SUCCESS message.



## Activating the Imported Setup File

1. Return to the MAIN MENU
2. Scroll down to SETUP on the MAIN Menu and press the ENTER  key. This will display the *Setup Files* screen.



3. Scroll down to SELECT on the *Setup Files* screen and press the ENTER  key. This will display the *setup files* in the unit.



4. Scroll down to the *setup file* you wish to activate press the ENTER  key. This will *activate* the setup file.
5. Press the ENTER  key to close the activated message.

## Renaming a Data or Setup File

When renaming a Setup File start at the *Select Setup File Screen* on the unit.

HOME / SETUP / SELECT

When renaming a Data File start at the *Select Data File* screen on the unit.

HOME / VIEW DATA

1. Using the ▲UP / ▼DOWN keys highlight the desired file to be renamed.

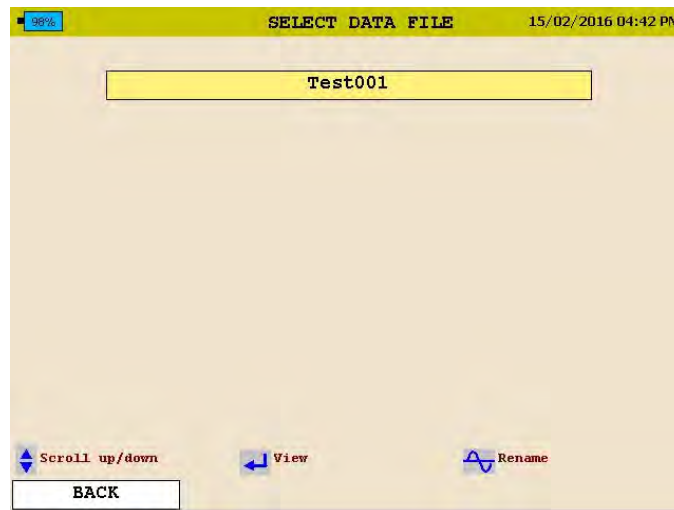



2. Press the SCOPE button to activate the keypad.

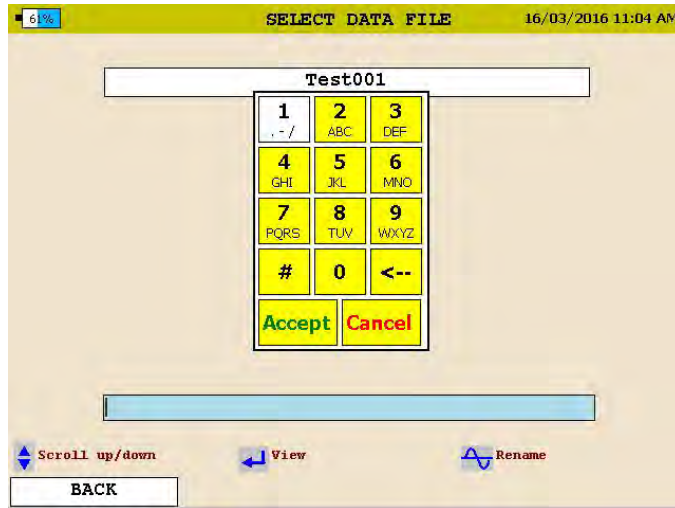

3. Using the ▲UP / ▼DOWN / ◀ LEFT / ▶ RIGHT keys navigate to the desired letter / number.



4. Press the ENTER  key until the desired letter / number is displayed.
5. When the desired name is created scroll over the ACCEPT and press the ENTER  key. The file name will now be changed.

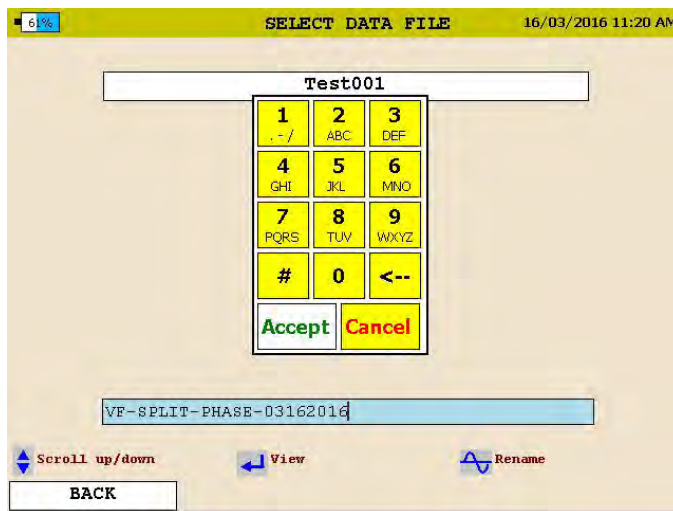

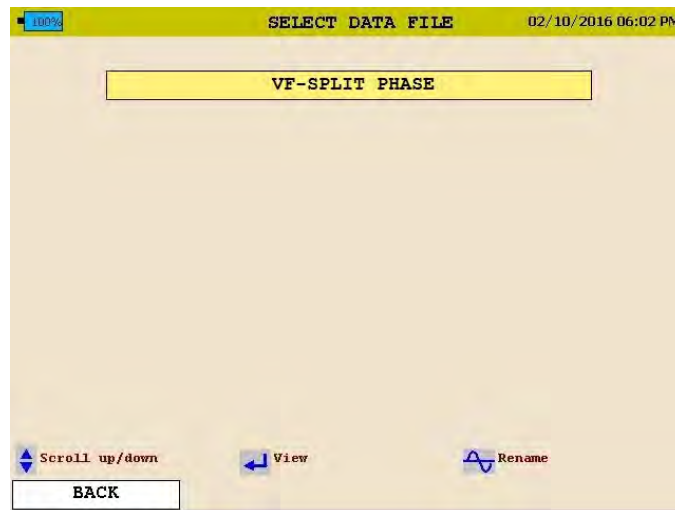

- To *backspace*, use the "<" symbol.
- To enter a *dot* ".", *dash* "-", or *underscore* "\_", use the "1" key
- No spaces are allowed in the file names.

# 7

## Installing the MPQ1000 Analyzer



### WARNING!

Be sure to use all appropriate safety equipment when installing the MPQ1000 PQ Analyzer. Failure to do so can result in injury or death.



### CAUTION

Inspect all power cords and wires for proper insulation integrity before connecting to any power source.



### WARNING!

Exposure to excessive dust and submersing in water may result in equipment damage.



### CAUTION

Turning on analyzer before completing all electrical connections, or turning off analyzer after removing any electrical connections may result in erroneous readings.

The installation procedure consists of:

1. Charging the units battery prior to use.
2. Ensure that the MPQ1000 PQ Analyzer is not exposed to water, excessive dust, and other hazardous conditions. The MPQ1000 PQ Analyzer is not meant for outdoor use.
3. Making electrical connections.

**Always complete all connections before beginning recording. Always stop recording before removing connections.**

## **Battery**

### **Battery Charging**

Always ensure that the battery is properly charged. It must maintain a 12-volt minimum for proper recording operation. A battery charge indicator on the MPQ1000 display allows you to view the batteries state of charge.

*NOTE: The battery should be charged prior to recording with the unit powered off.*

### **Charging the MPQ1000 Battery**

A DC adapter is provided as standard equipment with the MPQ1000. This adapter both powers the unit and charges the internal NiMH batteries within the unit.

Plug the AC adapter into the MPQ1000 unit using the DC input jack. Then plug the adapter into a standard AC outlet (110V-240VAC 50Hz/60Hz). The battery should fully charge in approximately 2 hours.

### **Battery Storage**

The MPQ1000 NiMH battery self-discharges an average of 1%/ day at room temperature. If left for 90 days at room temperature, the cells can fully discharge. Cell reversal can occur, which will damage the cells.

Fully charge the battery before storage. Store it in a cool dry area. Recharge battery pack within 90 days after initial storage - sooner if stored above 30C.

### **Installation**

1. The MPQ1000 is an IP51 rated device. Ensure that the MPQ1000 PQ Analyzer is not exposed to water, excessive dust, and other hazardous conditions. The MPQ1000 PQ Analyzer is not meant for outdoor use.

The MPQ1000 comes with an optional strap for hanging the analyzer.

2. **Plug the AC adapter into the MPQ1000 unit using the DC input jack. Then plug the adapter into a standard AC outlet (110V-240VAC 50Hz/60Hz).**



## Voltage and Current Connections

If you will not be recording demand parameters, voltage and current can be connected to any input. The connections do not have to be in pairs, but the voltage channels and current channels must be sequenced.

**NOTE:** *Current probes not purchased from Megger require Megger adapters.*

To install the Power Analyzer using current clamps, plug the selected clamps into the current input connectors then clamp around the source to be measured. An arrow on the current clamp indicates the direction of the load.

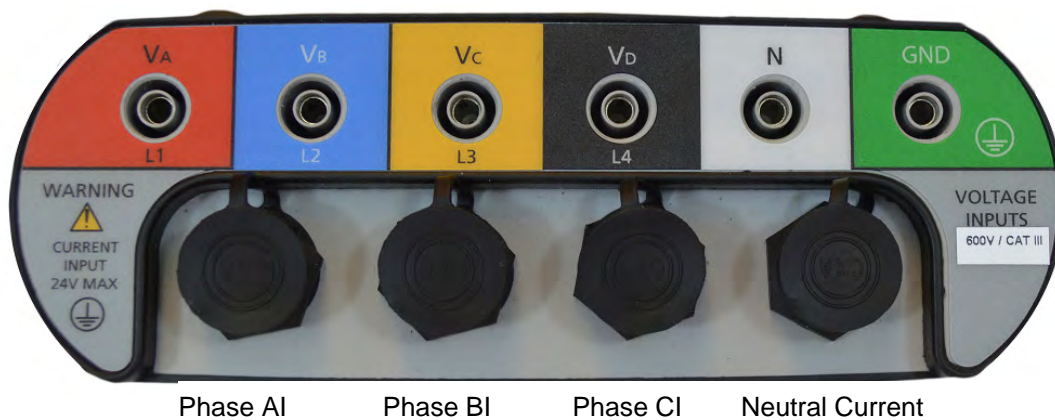

**Megger.**

# 8

## WIRING DIAGRAMS for Demand Recording

### *Notes on Wiring Diagrams*

1. The Power Analyzer records all voltages and currents that are hooked up providing you have activated channels in the setup. Even though not all channels may be required for the power configurations on the following pages, you can connect them to obtain voltage/current recordings, providing you activate the channel.
2. The vector diagrams shown are for reference and represent the vectors associated with a balanced resistive load. Reactive currents will rotate the current vectors clockwise or counterclockwise with respect to the voltages.
3. In the 3-wire configurations, you may select any one wire as a voltage reference, but you must place current clamps on the remaining two wires.
4. In the 3-wire configurations, the 2-element wattmeter method is used for power calculations. The third voltage and current can be connected to the Power Analyzer but will be recorded as RMS data only, providing you activate the channels.



#### **CAUTION**

**Inspect all power cords and wires for proper insulation integrity before connecting to any power source.**

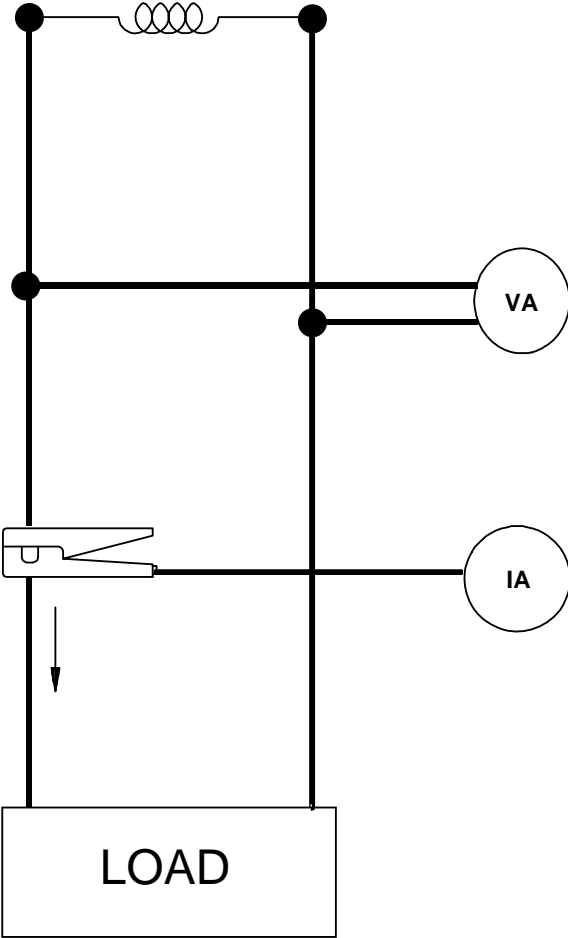

**2-WIRE  
SINGLE PHASE  
SINGLE WATTMETER**

**ROTATION  
N/A**

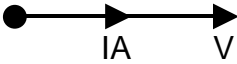

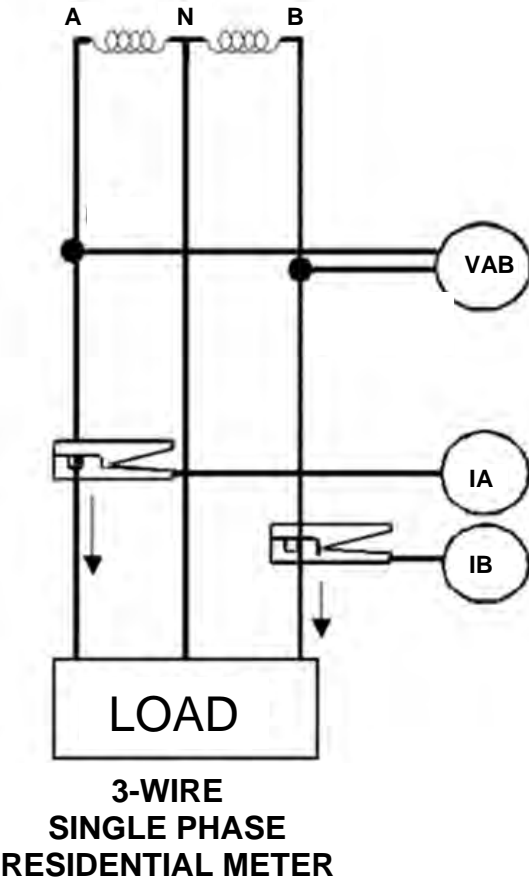

ROTATION  
N/A

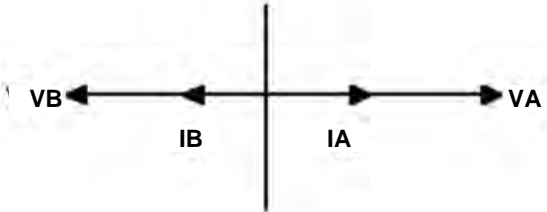

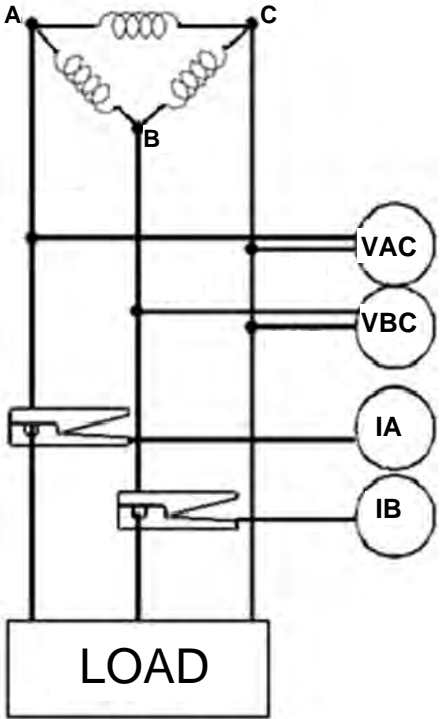

**3-WIRE  
DELTA CONNECTION  
2- WATTMETER METHOD**

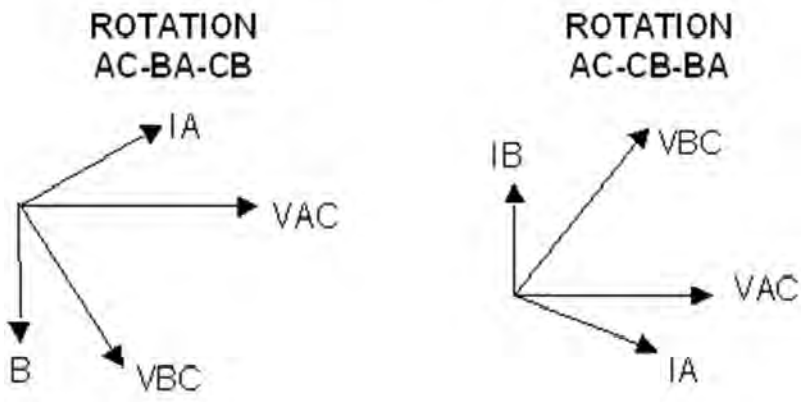

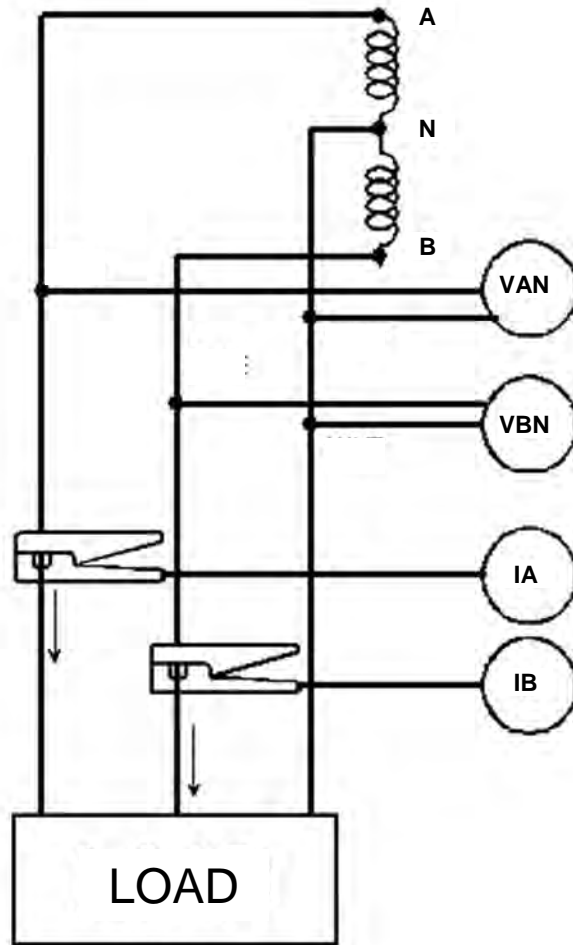

**3-WIRE  
SPLIT PHASE  
2- WATTMETER METHOD**

**ROTATION  
N/A**



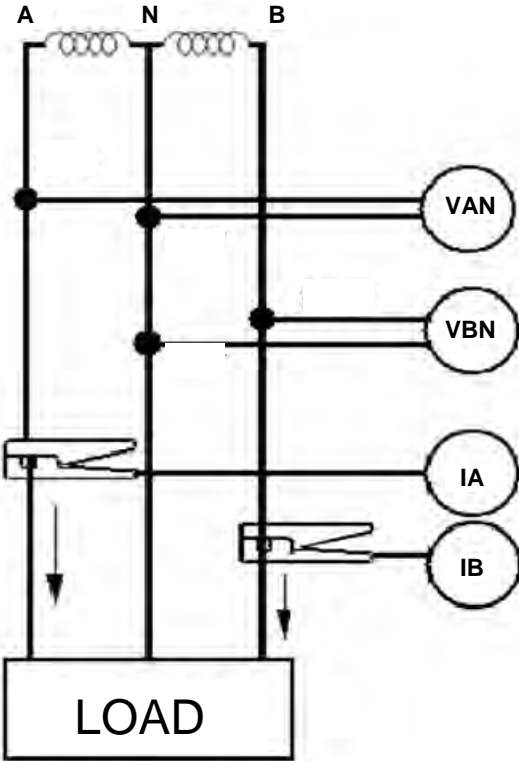

3-WIRE NETWORK METER

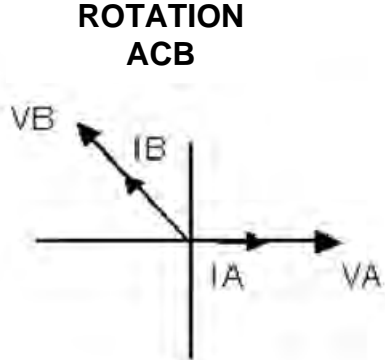
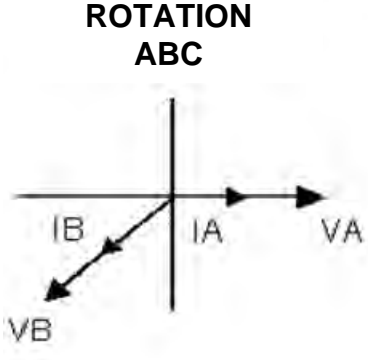



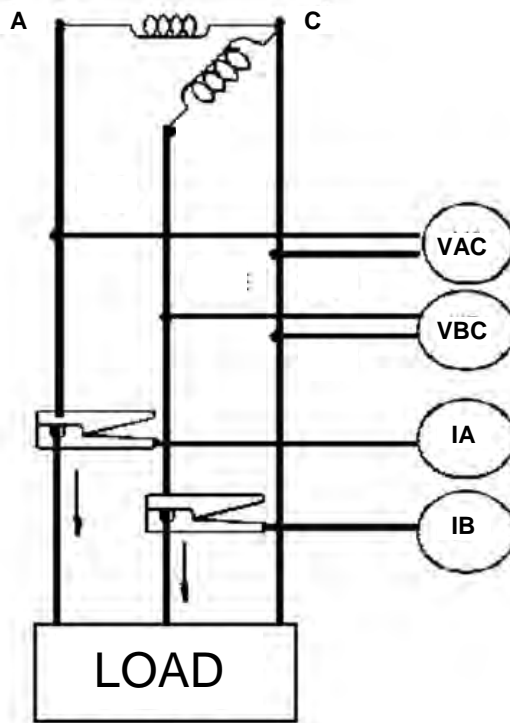

**3-WIRE  
OPEN DELTA  
2-WATTMETER METHOD**

**ROTATION  
AC-BA-CB**

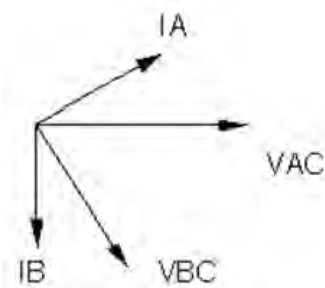

**ROTATION  
AC-CB-BA**

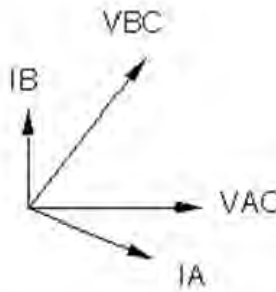

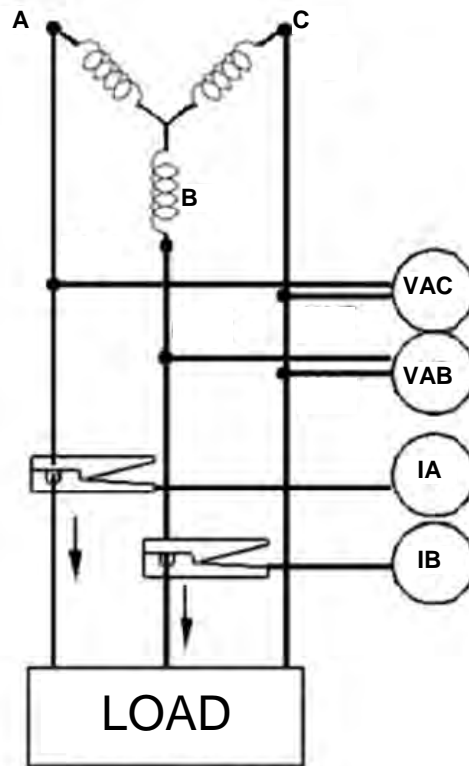

**3-WIRE  
WYE CONNECTION  
2-WATTMETER METHOD**

**ROTATION  
ABC**

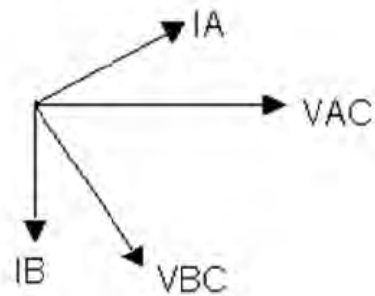

**ROTATION  
ACB**

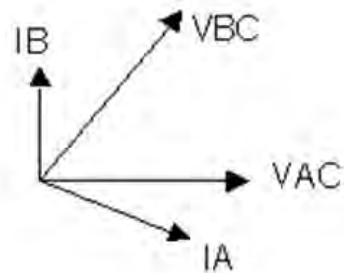

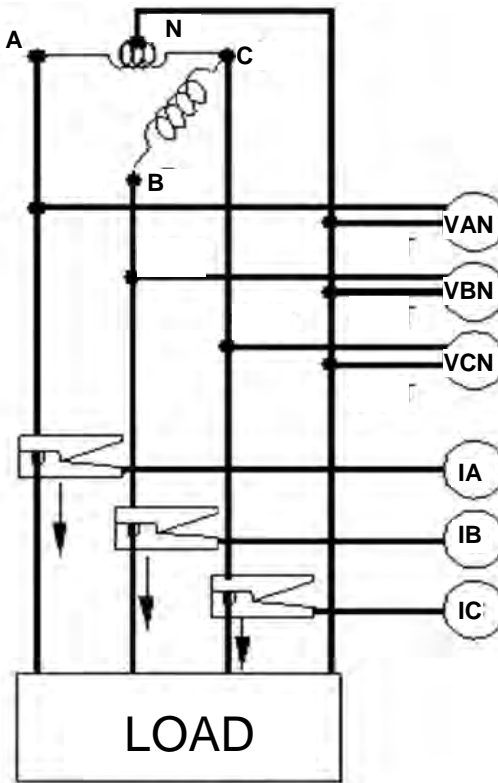

**4-WIRE  
RED-LEG OPEN DELTA  
3-WATTMETER METHOD**

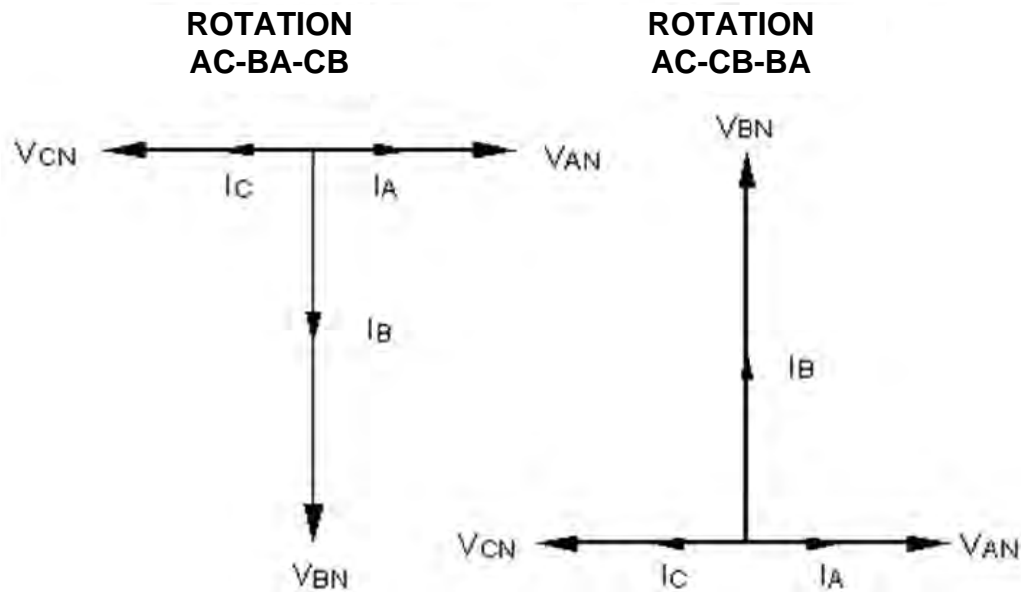

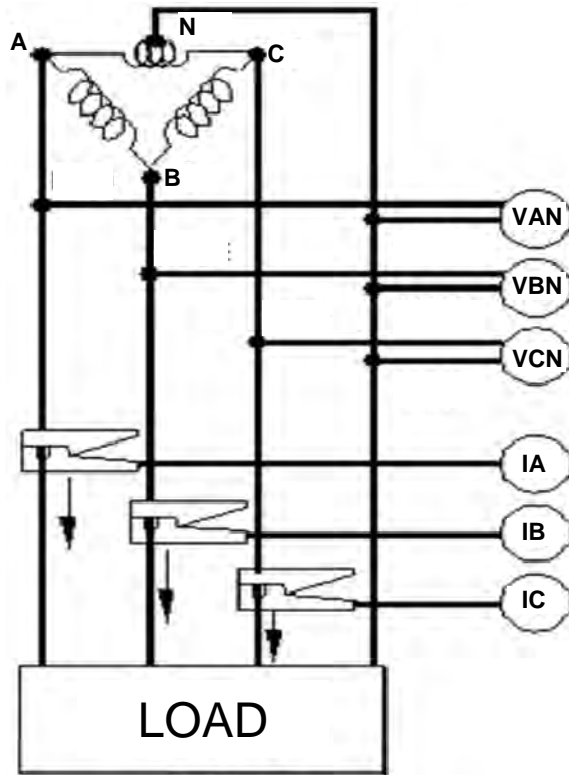

**4-WIRE  
RED-LEG DELTA  
3-WATTMETER METHOD**

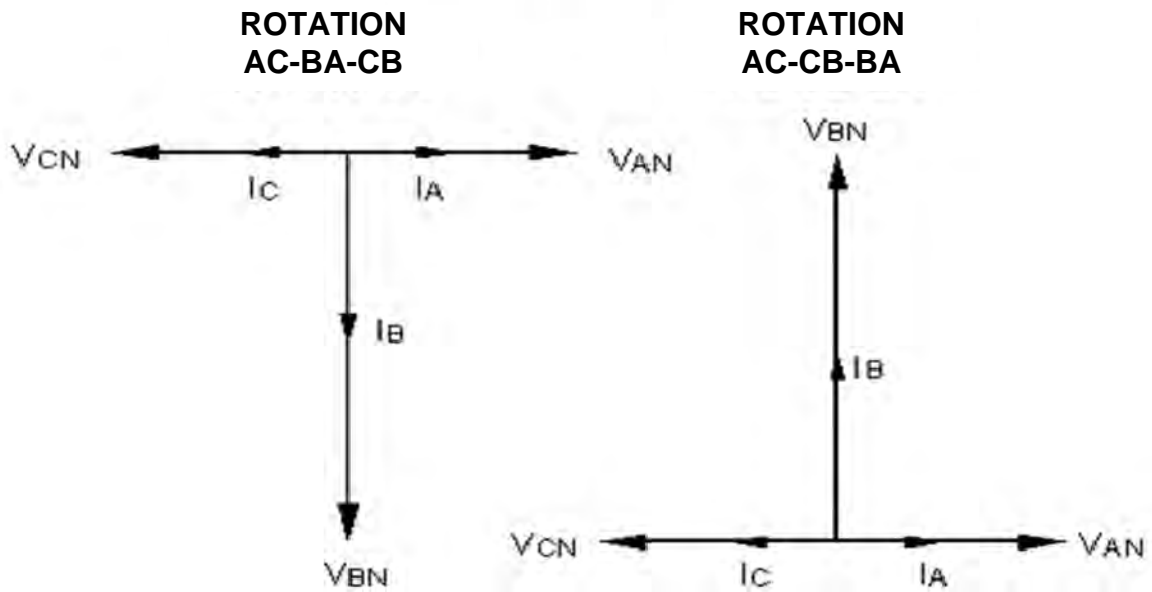

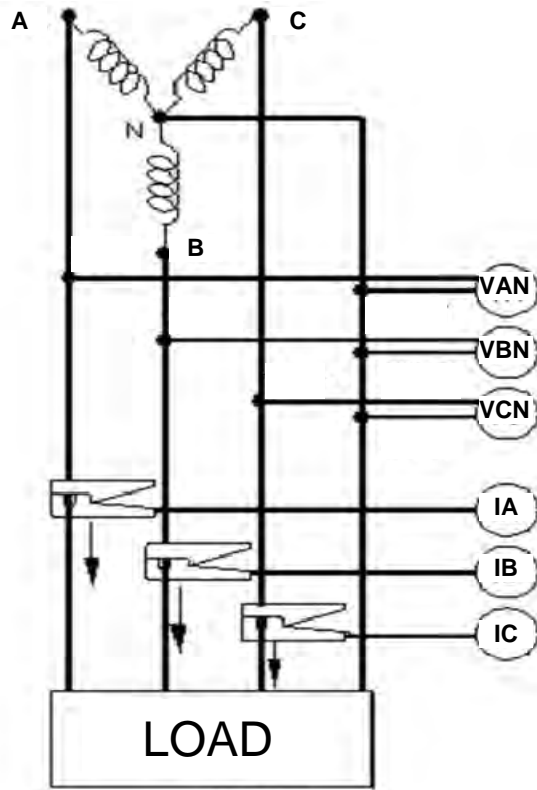

**4-WIRE  
WYE CONNECTION  
3-WATTMETER METHOD**

**ROTATION  
ABC**

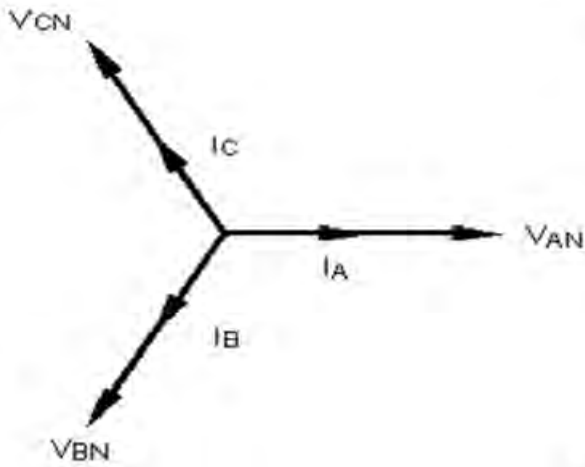

**ROTATION  
ACB**

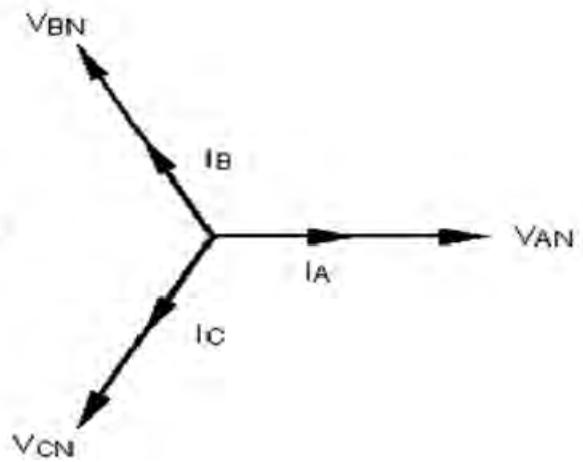

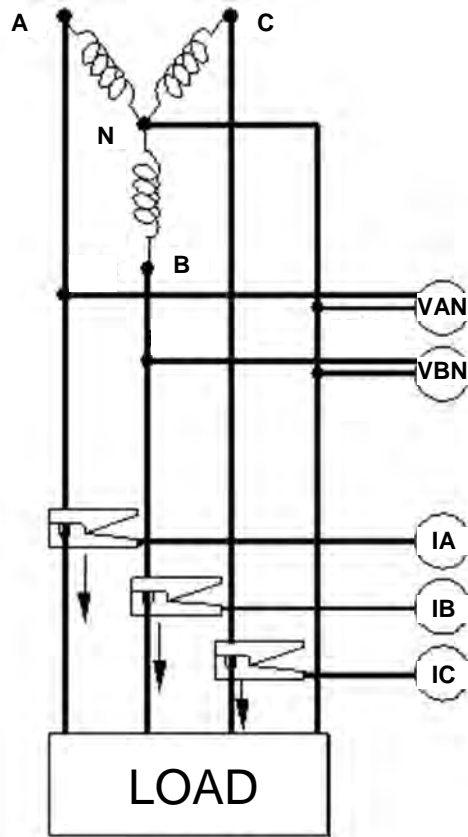

**4-WIRE  
WYE CONNECTION  
2½- WATTMETER METHOD**

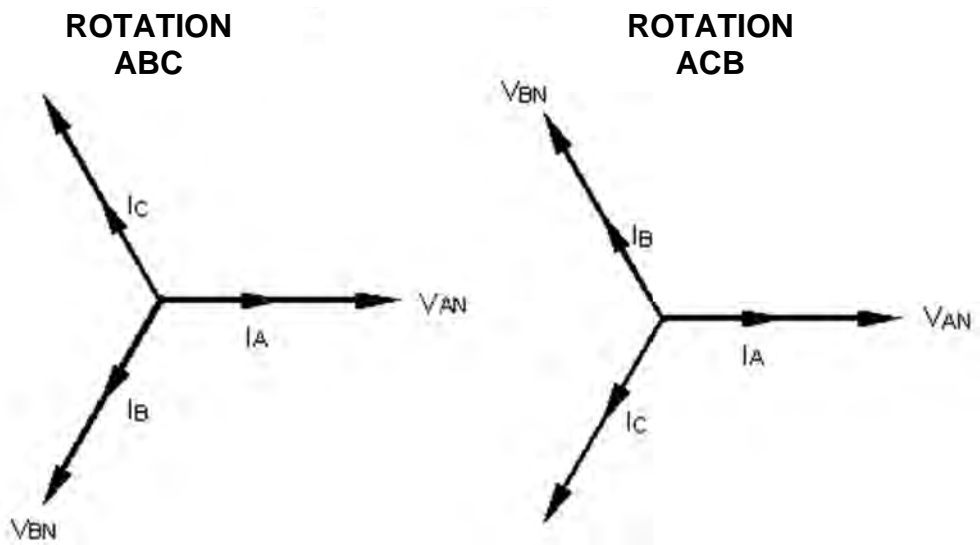

## Floating Wye Neutral Measurement

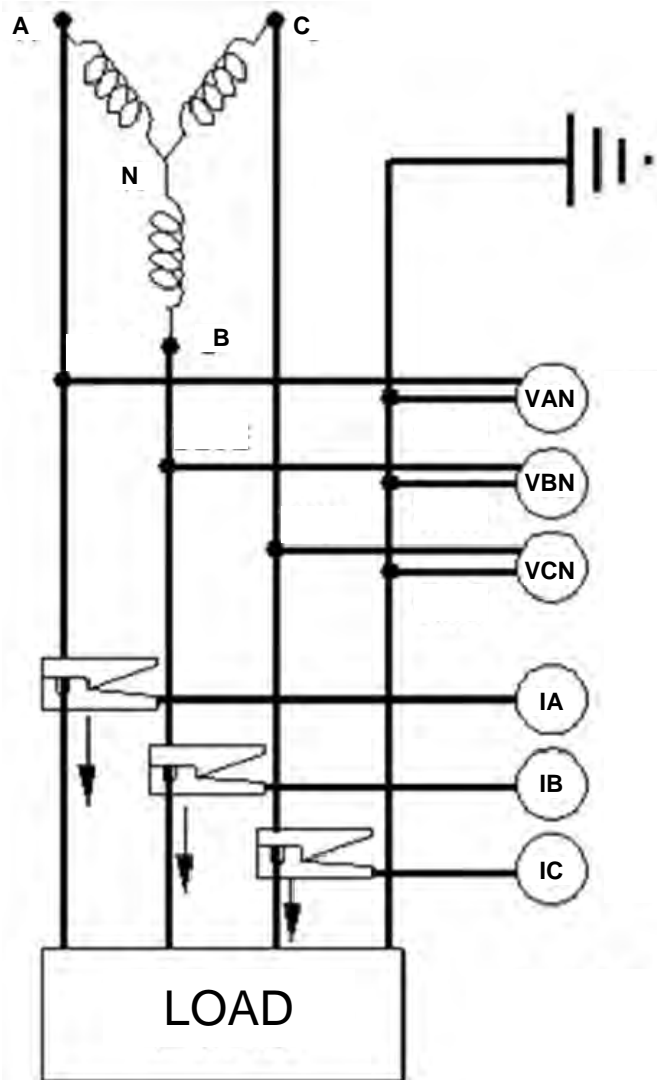

**FLOATING WYE CONNECTION  
4-WIRE WYE CONNECTION  
3-WATTMETER METHOD**

## Verify Active Setup File

1. From the Main Menu scroll down to SETUP and press the ENTER ↵ key.



2. This will take you to the SETUP menu. Scroll down to SELECT and press the ENTER ↵ key.



The *active* Setup File will have an asterisk in front.



# 9

## Starting and Stopping a Recording

Before starting a recording is best to verify the current clamps are set to the proper range and the analyzer is connected properly.

### *Verify the Input Connections*

Before starting any test, verify that you have hooked up all the inputs required for the active setup program. Press the DMM short cut key to enter the DMM mode. You can then view all voltage and current values the unit is connected to.

DMM MODE 02/10/2016 04:52 PM

	VOLTAGE		CURRENT
	VOLTAGE (V)	THD (%)	CURRENT (A)
PHASE A	121.76	0.00	873.24
PHASE B	121.81	0.00	978.68
PHASE C	121.76	0.00	743.47
NEUTRAL	0.00	0.00	0.00
GROUND	--	--	0.09

Select function

HOME POWER HARMONICS UNBALANCE

Use the arrow keys to scroll over to the POWER selection. Verify the KW measurements are positive. If they are not then a current probe may be backwards. Verify the voltage and current phase angles are correct for the active setup file.

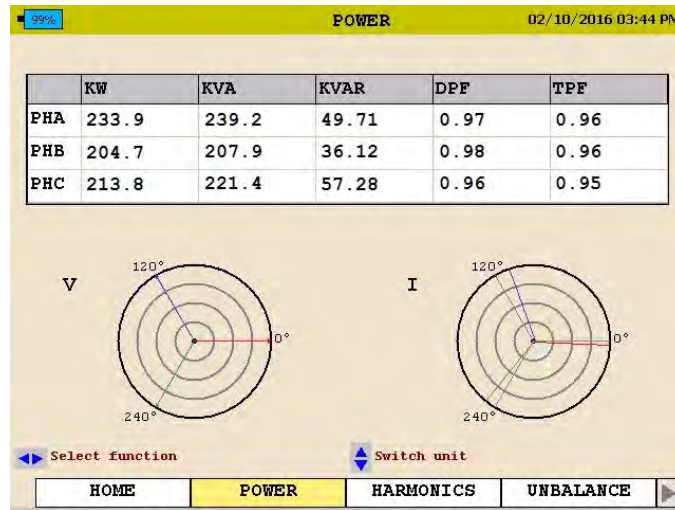

## Starting a Recording

Once the connections are verified, press the RECORD button to start the recording.



The analyzer will verify the inputs and settings before starting the recording. The analyzer will verify the following:

- The default frequency is correct.
- The inputs are correct for the power parameters selected.
- The current clamps are set to the proper range.
- The phase angles are correct for the configuration selected.

If any of the above is found to be incorrect the analyzer will display a message. The message will indicate what parameters and channel is incorrect and how to correct it.

**NOTE:** *If the range setting on the CT does not match the range in the setup file then the analyzer will display a message indicating the CT channel that is set incorrectly.*

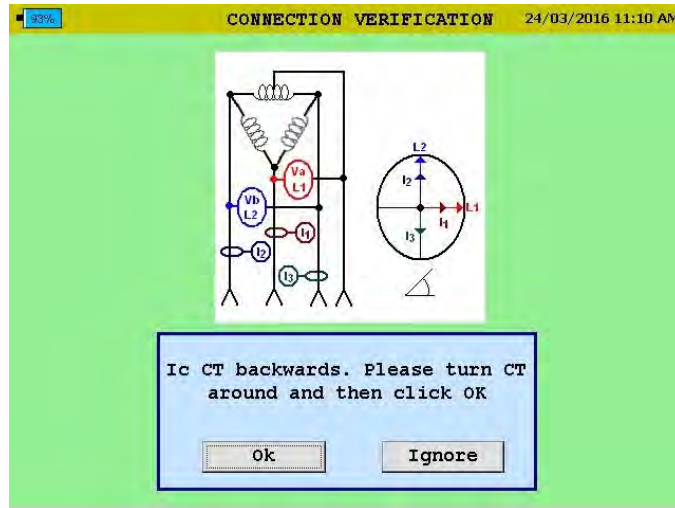

The operator has the option to do the following:

- Manually change the range on the CT to the correct range.
- Have the analyzer automatically change the range in the setup file to match the range setting on the CT.
- Ignore the mismatch. *Please note: if this option is chosen the current values recorded will be incorrect.*

The analyzer will check the CT ranges for each channel individually. Therefore it is possible to get the same message 3 times. Each message will display a different channel.

Once the analyzer determines the configuration is correct it will start the recording and the following screen will appear.

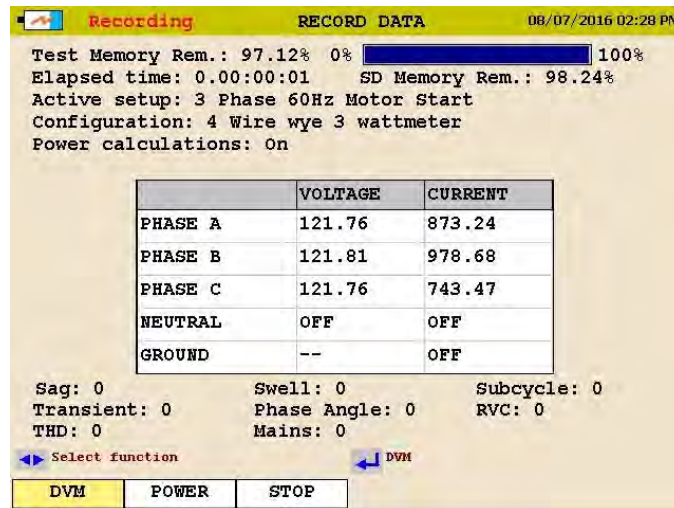

This screen will display the *Duration of the Recording, the Time Remaining, the Voltages and Currents* as well as any events that have been captured.

During the recording the mode the analyzer does not display scope mode functions.

The user can use the arrows to scroll over to POWER to view the power and energy parameters during the recording.

- To stop the recording, press the RECORD key again.

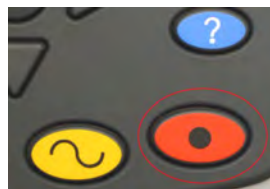

If the display on the analyzer is off, pressing the RECORD key will first turn on the display.

- Press the RECORD key a second time to stop the recording.

A message will appear asking if you are sure. Press the ENTER key and the recording will now be stopped.



# 10

## Downloading Data from the MPQ1000

The data from the MPQ2000 can be retrieved in several different manners.

- The data can be transferred through the type B USB Port directly to the PC.
- The data can be transferred through the Ethernet Port directly to the PC.
- The data can be transferred to a USB stick plugged into the type A USB port.
- The data can be imported directly from the SD Card.

### ***Transfer data to a PC via SD Card, Ethernet or USB Cable***

See the MEGGERPQ software manual

### ***Transfer data to a USB Stick***

1. Power up the MPQ2000 using the power adapter.
2. Insert the USB stick into the type A USB port in the unit.
3. From the MAIN MENU scroll down to SD CARD and then press the ENTER ↵ key. This will display the SD CARD screen.



4. From the SD CARD scroll down to EXPORT TEST DATA TO USB and then press the ENTER ↵ key.



5. Select EXPORT TEST DATA TO USB then press the ENTER ↵ key. The data transfer will now begin.
6. Once the data is transferred a success message will appear.

**NOTE:** See AVTMMEGGERPQ manual for transferring data from the USB stick or the SD card to the PC.

# 11

## Viewing Data on the MPQ PQ Analyzer

The MPQ PQ Analyzer will display the recorded data on the unit's display.

The MPQ Analyzer will trend the following data.

- RMS Voltage and Current
- Power
- Energy
- Power Factor
- THD
- Harmonics
- Inter-Harmonics
- Frequency
- Flicker

The MPQ Analyzer will display all the following events.

- Sags
- Swells
- Sub-cycle events
- High Speed Transients
- THD Events
- RVC
- Phase Angle Deviation
- Mains Signaling Events
- All charts and traces support a zoom function and a scan line.

The following sections show how to view the recorded data on the unit.

## Viewing an RMS Chart

Starting from the HOME Screen (Press  to open the HOME Screen):

1. Use the UP ▲ / DOWN ▼ to navigate through the menu options.
2. Press the ENTER ↵ key to select an option.



Select VIEW DATA



Select Data File

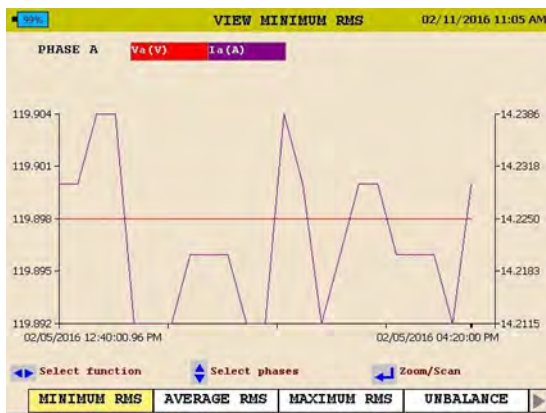

View RMS

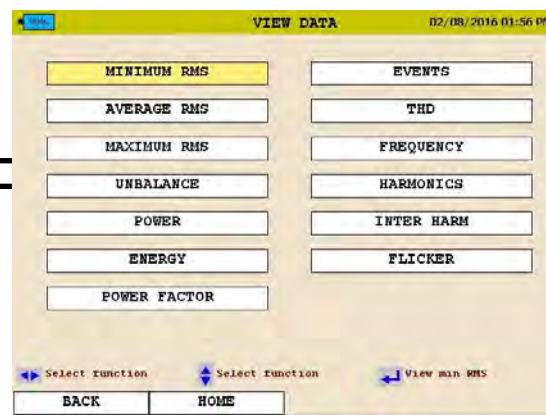

Select type of RMS chart then press ENTER to create chart.

See next page for RMS chart description.



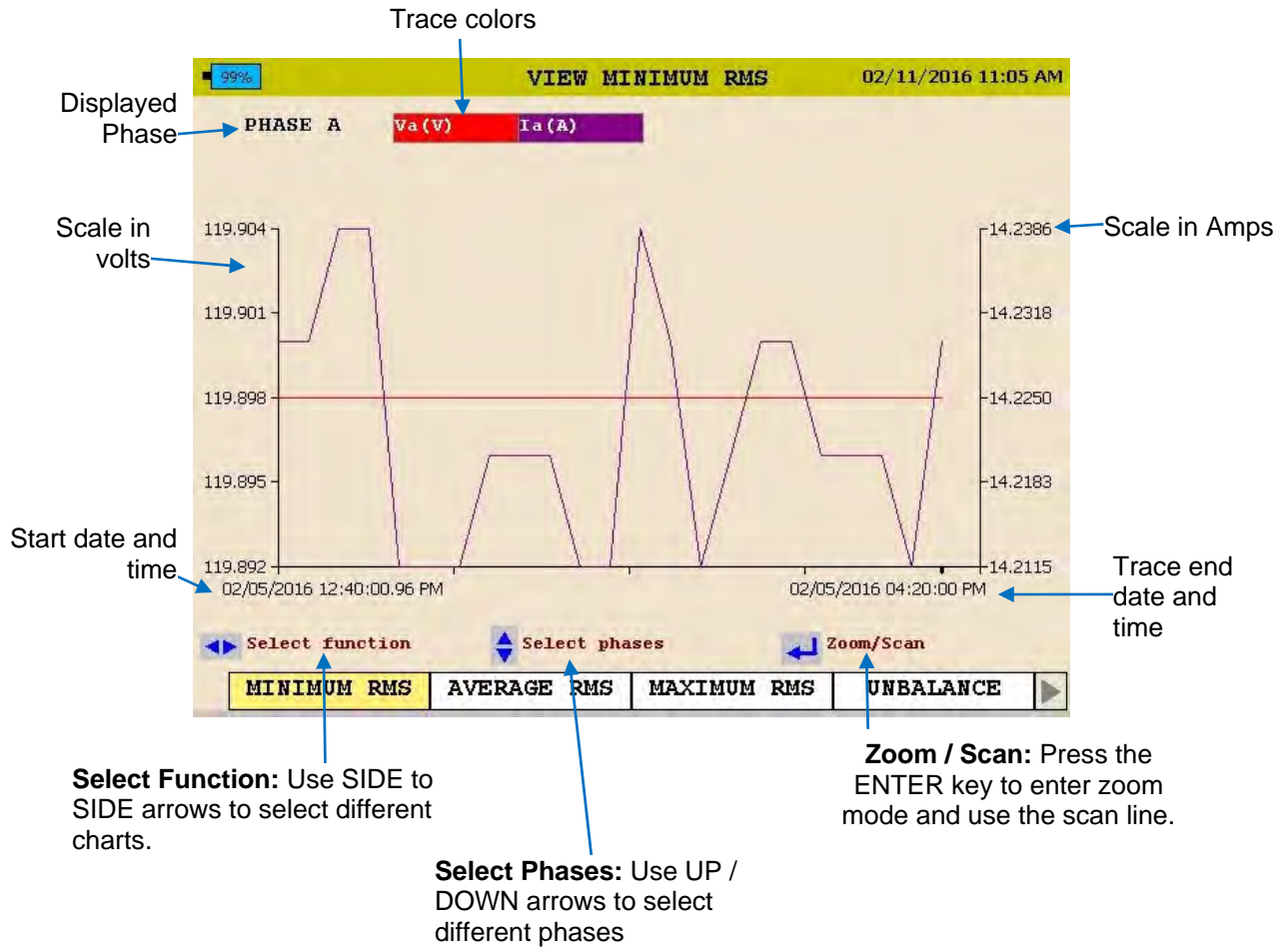

3. To EXIT chart, press the BACK ◀ button.

## Viewing a Unbalance Chart

Starting from the HOME Screen (Press  to open the HOME Screen):

1. Use the UP ▲ / DOWN ▼ to navigate through the menu options.
2. Press the ENTER ↵ key to select an option.



Select **VIEW DATA**



Select Data File

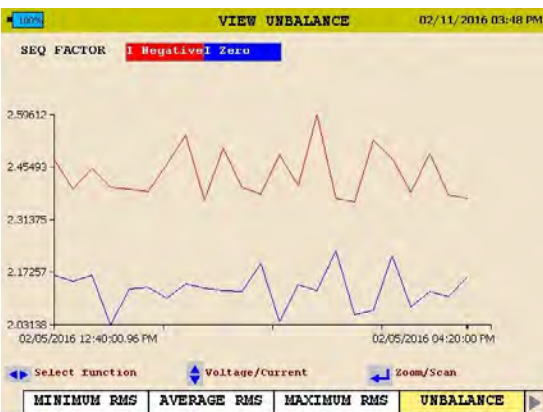

View **Unbalance Chart**



Select **UNBALANCE** then press **ENTER** to create chart.

See next page for unbalance chart description

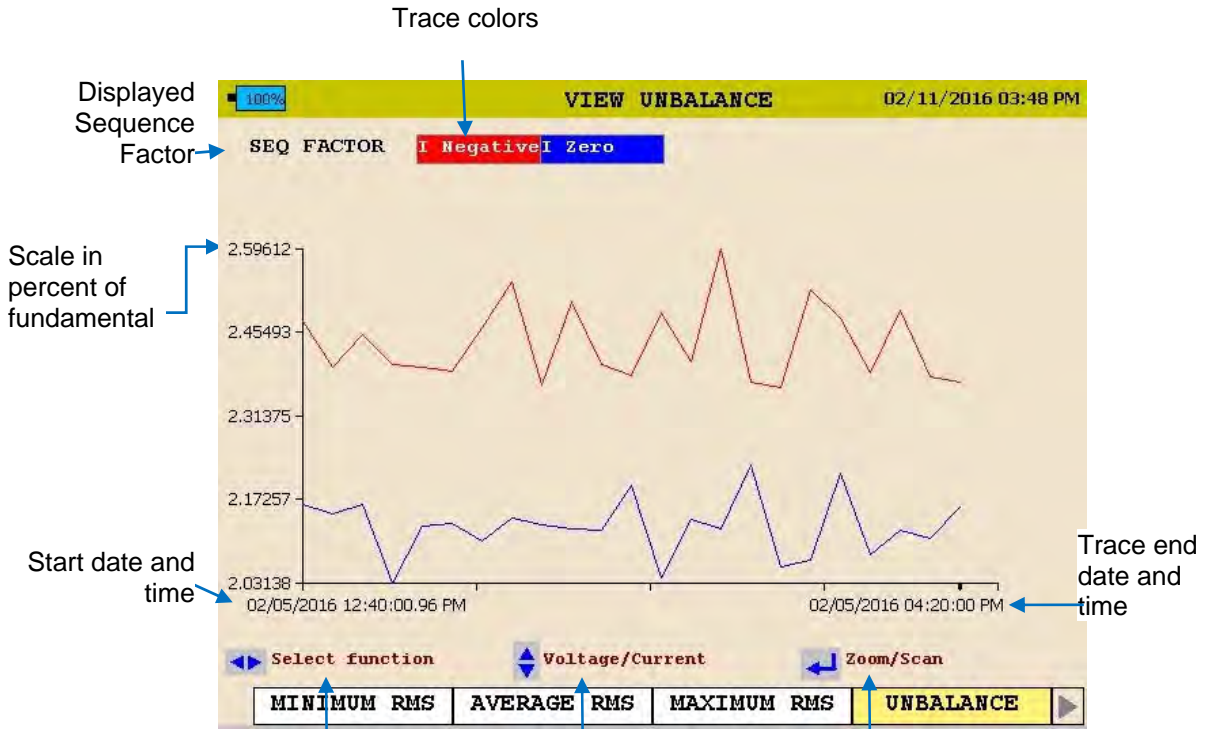

**Select Function:** Use SIDE to SIDE arrows to select different charts.

**Select Phases:** Use UP / DOWN arrows to select different phases

**Zoom / Scan:** Press the ENTER key to enter zoom mode and use the scan line.

3. To EXIT chart press the BACK ◀ button.

## Viewing a Power or Energy Chart

Starting from the HOME Screen (Press  to open the HOME Screen):

1. Use the UP ▲ / DOWN ▼ to navigate through the menu options.
2. Press the ENTER ↵ key to select an option.



Select VIEW DATA



Select Data File



View POWER CHART

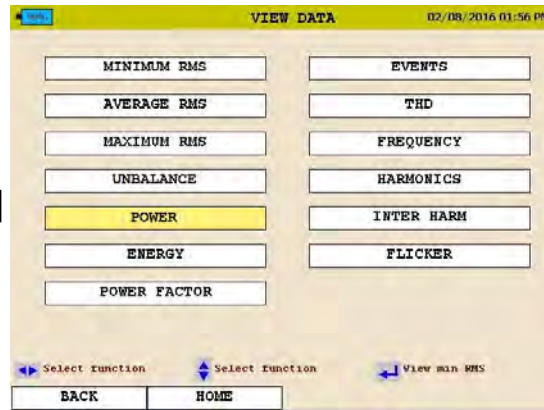

Select POWER or ENERGY then press ENTER to create chart.

See next page for Power and Energy chart description.



**Select Function:** Use SIDE to SIDE arrows to select different charts.

**Select Phases:** Use UP / DOWN arrows to select different phases

**Zoom / Scan:** Press the ENTER key to enter zoom mode and use the scan line.

3. To EXIT chart press the BACK ◀ button.

## Viewing a THD Chart

Starting from the HOME Screen (Press  to open the HOME Screen):

1. Use the UP ▲ / DOWN ▼ to navigate through the menu options.
2. Press the ENTER ↵ key to select an option.



Select VIEW DATA



Select Data File

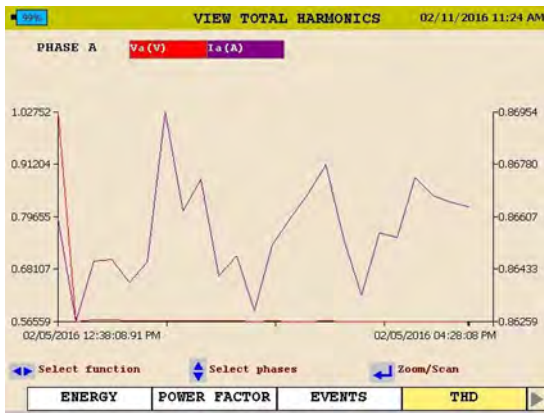

View THD CHART

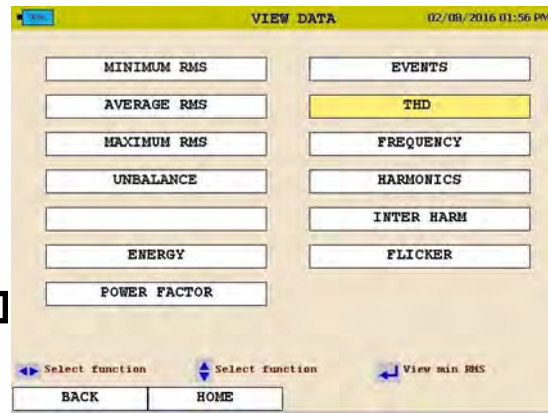

Select THD then press ENTER to create chart.

See next page for THD chart description.



**Select Function:** Use SIDE to  
SIDE arrows to select different  
charts.

**Select Phases:** Use UP /  
DOWN arrows to select  
different phases

**Zoom / Scan:** Press the  
ENTER key to enter zoom  
mode and use the scan line.

3. To EXIT chart press the BACK ◀ button.

## Viewing a Frequency Chart

Starting from the HOME Screen (Press  to open the HOME Screen):

1. Use the UP ▲ / DOWN ▼ to navigate through the menu options.
2. Press the ENTER ↵ key to select an option.



Select VIEW DATA

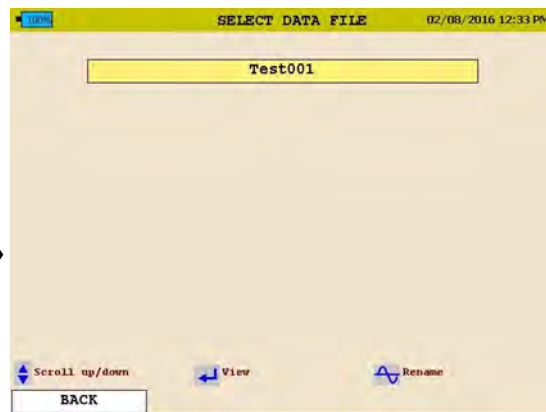

Select Data File

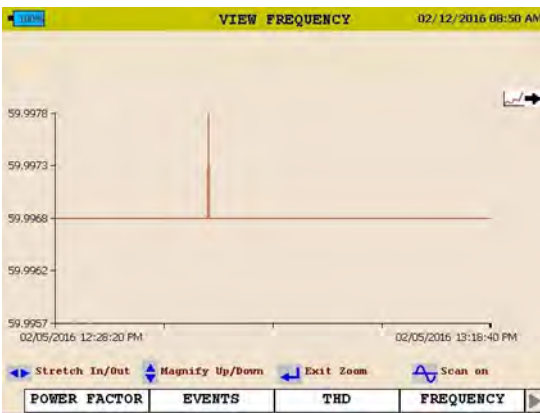

View FREQUENCY CHART

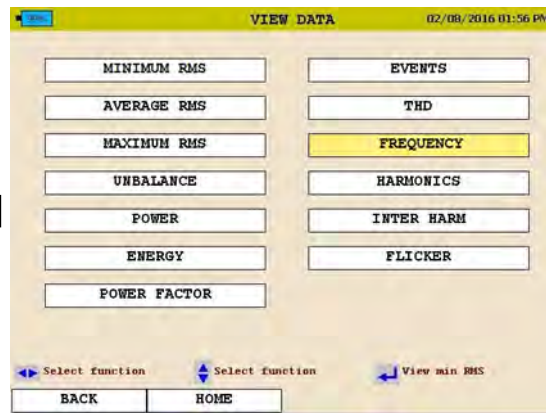

Select Frequency then press ENTER to create chart.

See next page for Frequency chart description



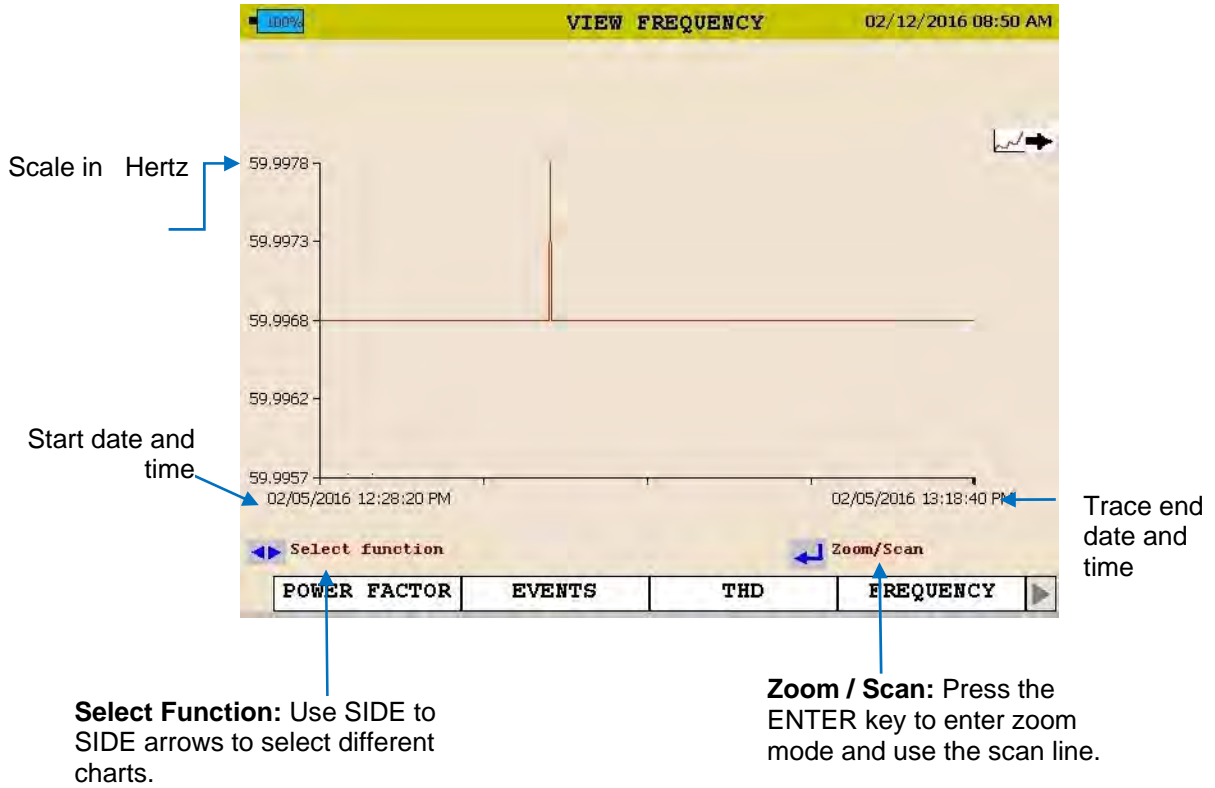

3. To EXIT chart press the BACK ◀ button.

## Viewing a Harmonics / Inter-Harmonics Chart

Starting from the HOME Screen (Press  to open the HOME Screen):

1. Use the UP ▲ / DOWN ▼ to navigate through the menu options.
2. Press the ENTER ↵ key to select an option.



Select VIEW DATA

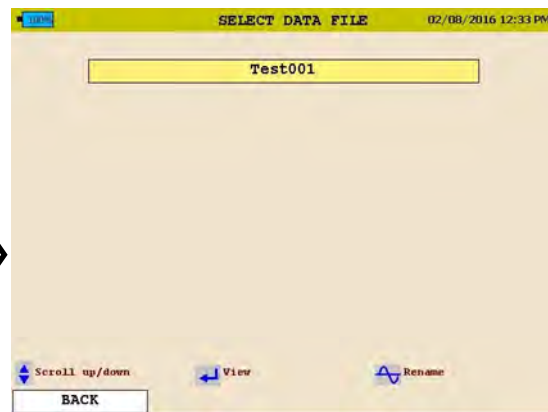

Select Data File

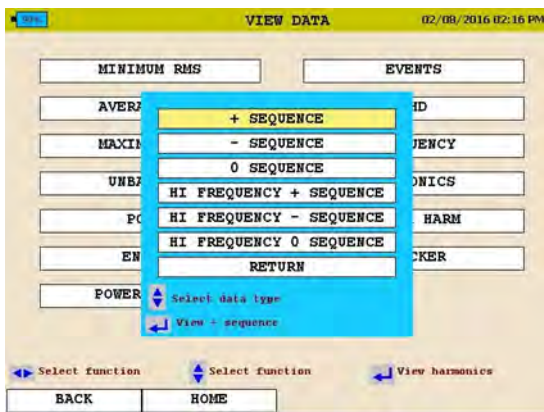

Select harmonic sequence then press ENTER to create chart.

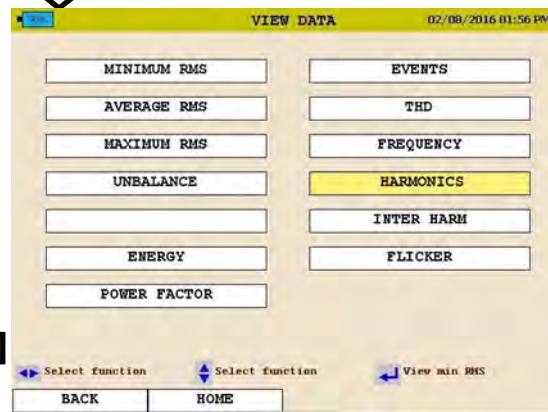

Select Harmonics or Inter-Harm (Inter-Harmonics).

See next page for Harmonic chart description

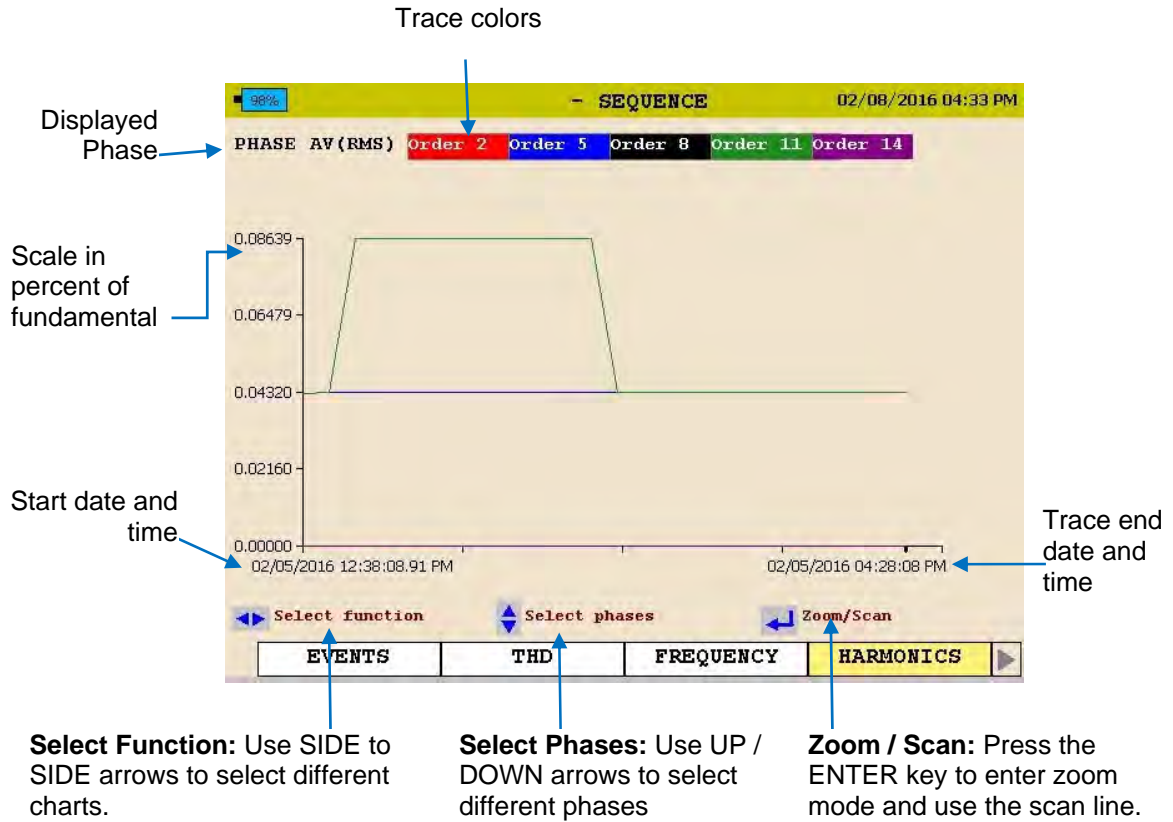

3. To EXIT chart press the BACK ◀ button.

The following screen shall be displayed.

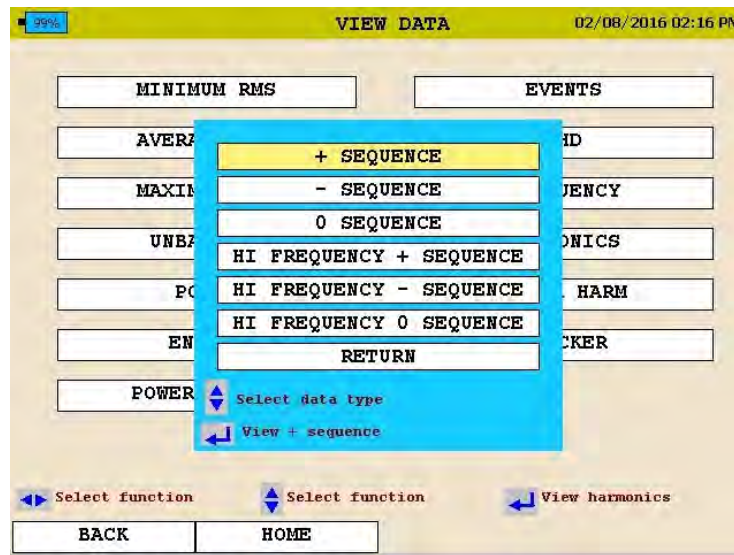

4. Scroll to RETURN and press the ENTER ↵ key.

## Viewing a Flicker Chart

Starting from the HOME Screen (Press  to open the HOME Screen):

1. Use the UP ▲ / DOWN ▼ to navigate through the menu options.
2. Press the ENTER ↵ key to select an option.



Select VIEW DATA



Select Data File

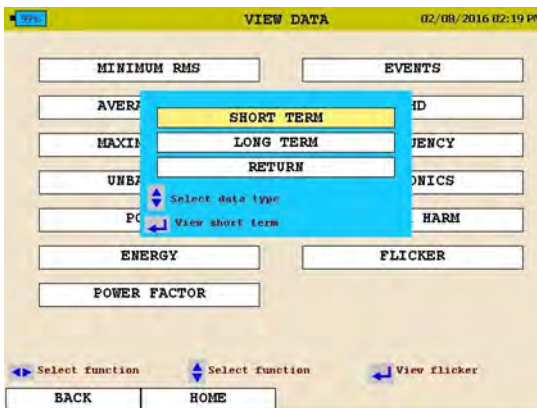

Select **Short Term** or **Long Term** then press **ENTER** to create chart.

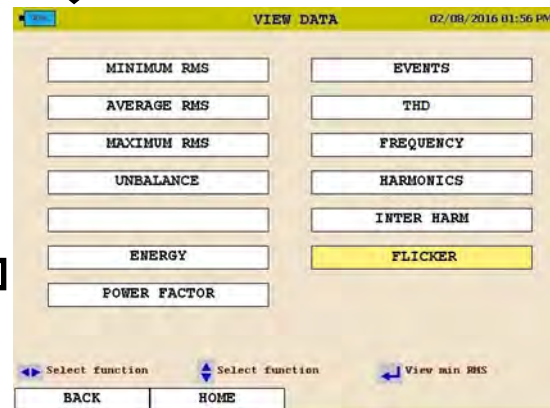

Select Flicker

See next page for Flicker chart description.

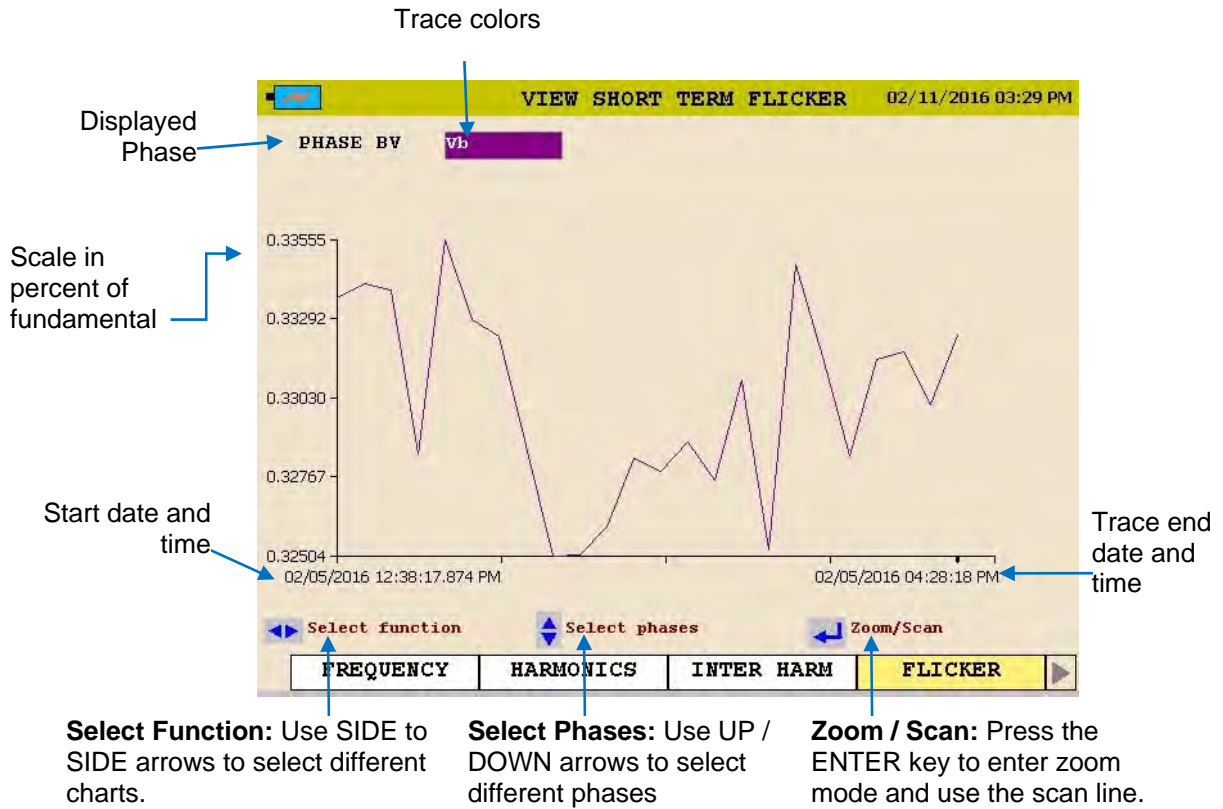

3. To EXIT chart press the BACK ◀ button. The following screen shall be displayed.

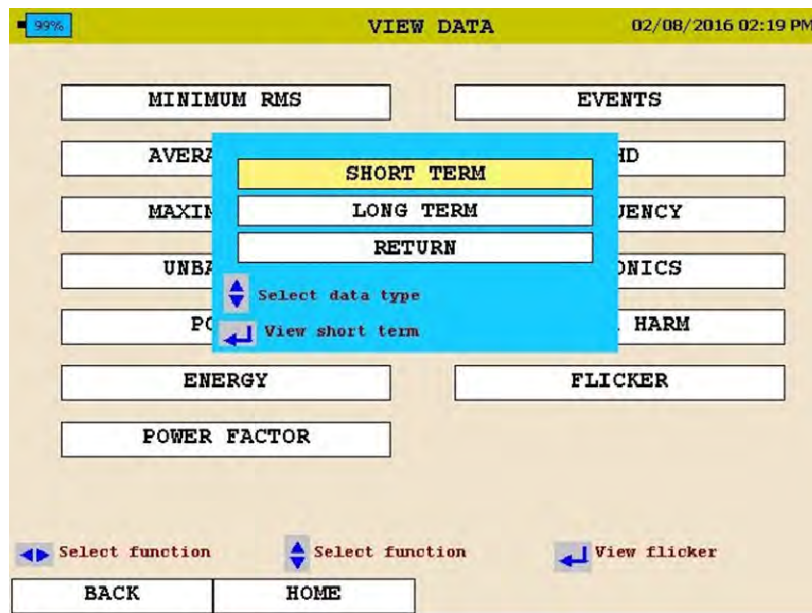

4. Scroll to RETURN and press the ENTER ↵ key.

## Viewing an Event Chart

Starting from the HOME Screen (Press  to open the HOME Screen):

1. Use the UP ▲ / DOWN ▼ to navigate through the menu options.
2. Press the ENTER ↵ key to select an option.



Select **VIEW DATA**

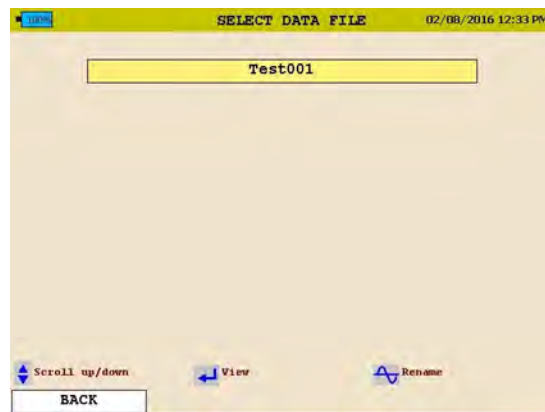

Select Data File



Select **type of event** using the **side to side arrows**, then press **ENTER** to select

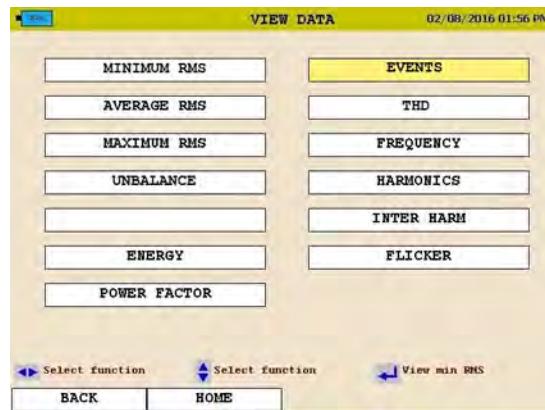

Select **Events**

See next page.

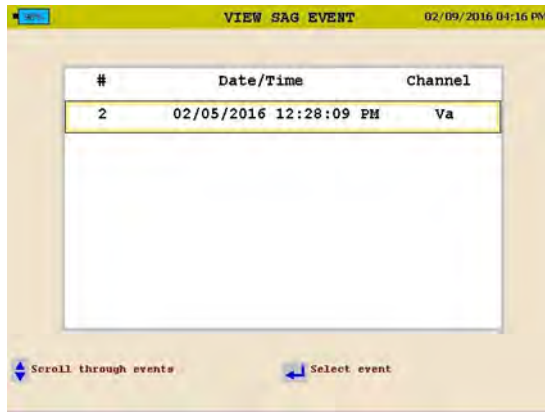

Select the date the event occurred.

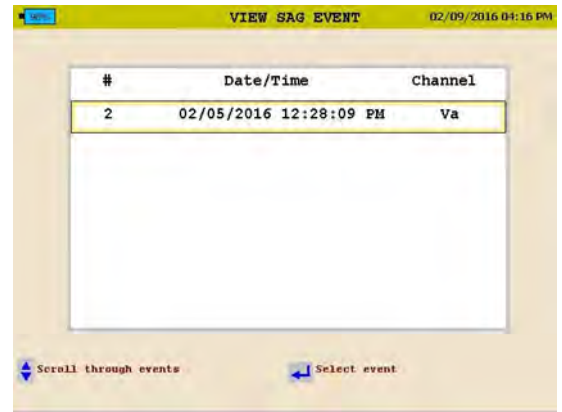

Select Event then press ENTER to create chart.

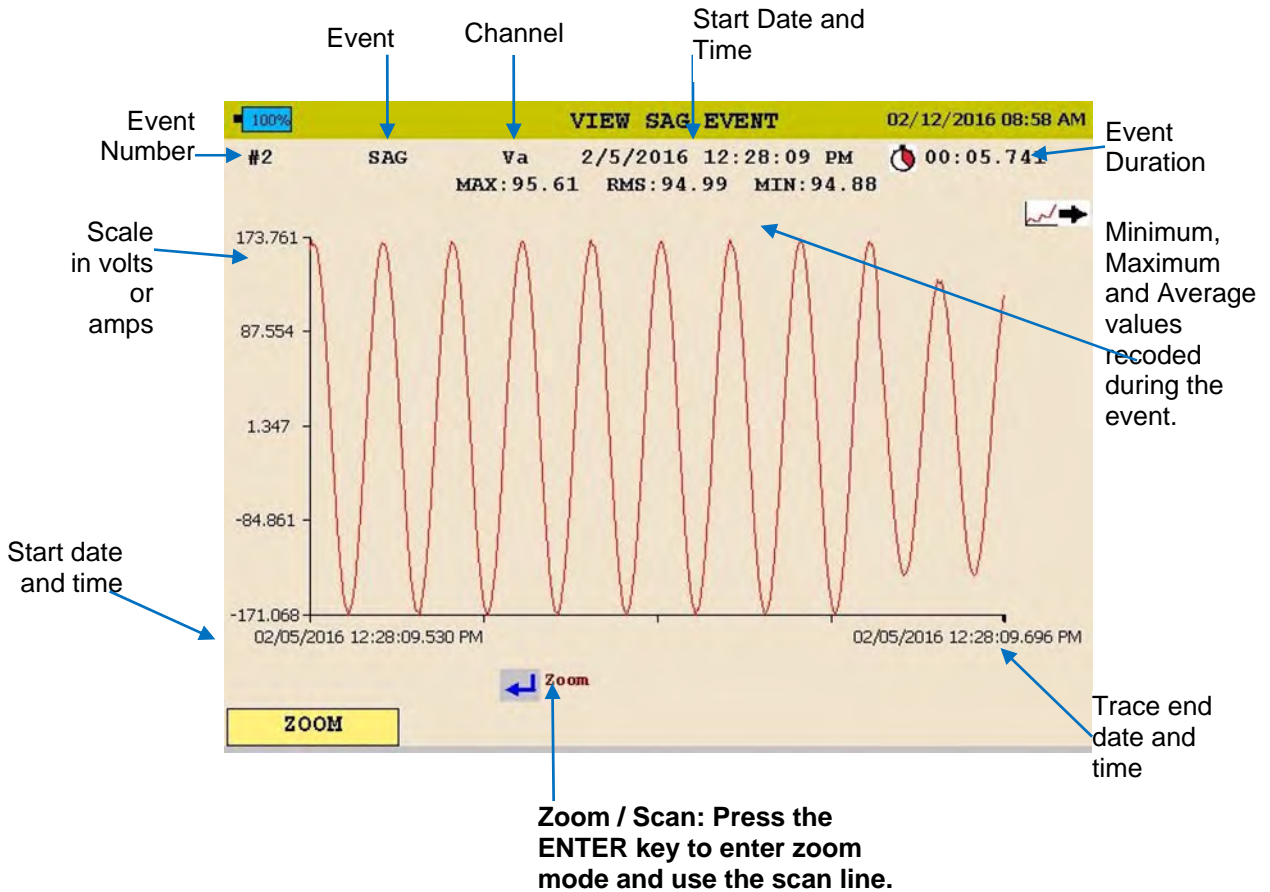

3. To EXIT chart press the BACK ◀ button and scroll through the options.

**Megger.**



# 12

## Unit Maintenance

*NOTE: Battery Life: Typically 500 charge / discharge cycles.  
The battery life may vary depending on how the battery is maintained.*

### **Battery Replacement**

The following procedure should be followed when replacing the MPQ1000 battery:

1. If the unit is on, turn the unit off by pressing and releasing the ON/OFF button.
2. Disconnect the external power supply, if it is connected.
3. Remove the stand to gain full access to the battery compartment door.

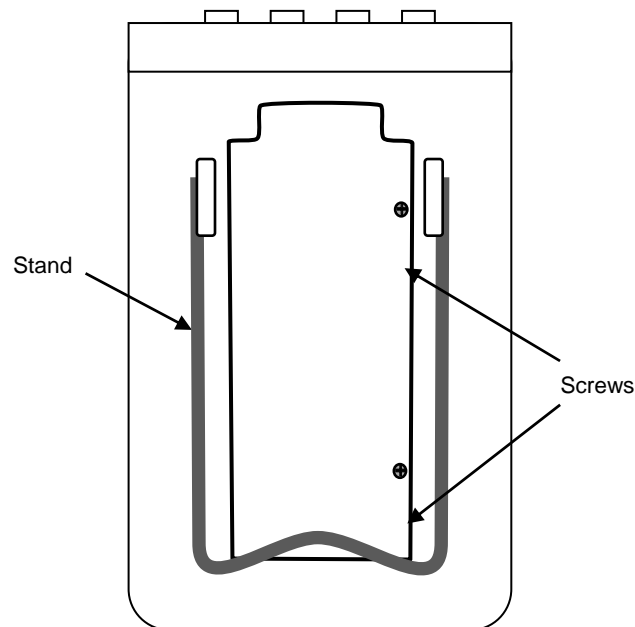

4. Loosen the battery compartment door retaining screws and remove the battery compartment door.

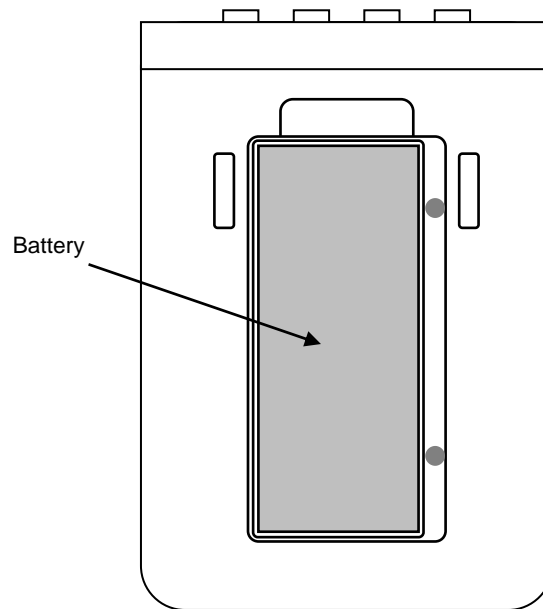

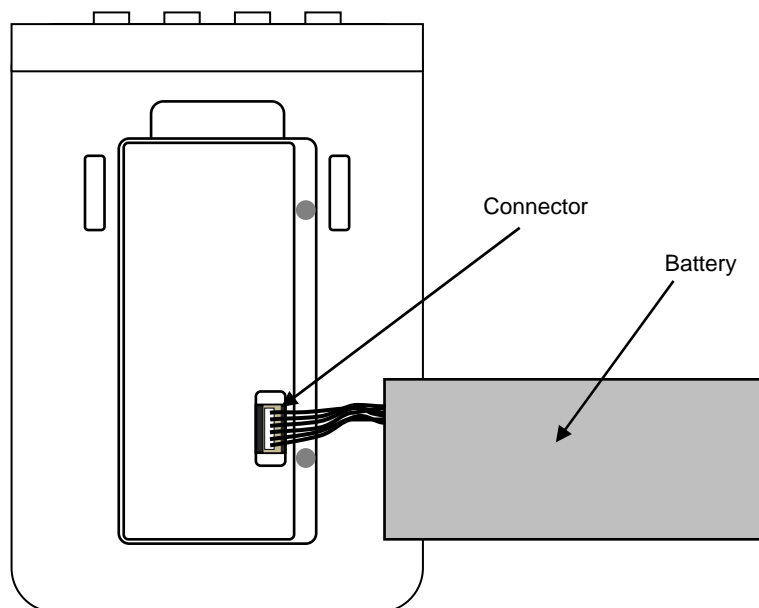

5. Lift out the battery from the top end and rotate to the side.

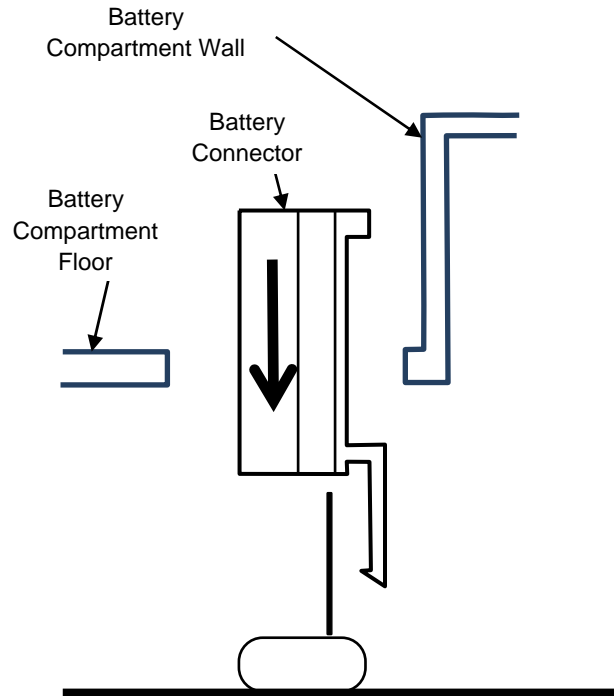

6. Grasp the wires between the battery and the connector and pull straight up until the connector unplugs from the PQ-1000.
7. Connect a new battery to the PQ-1000 by aligning the battery connector to the pins and pressing it in place.



8. Place the battery in the battery compartment with the wires under it.
9. Put the battery compartment door back in place and tighten the retaining screws.
10. Put the stand back in place.
11. Turn on the PQ-1000 by pressing and releasing the ON/OFF button. The battery status indication should indicate 0%. The battery status indicator must be initialized before it will display the true charge level of the battery. This is done by discharging the battery to below 10% of its capacity.
12. Go to the SETUP > PREFERENCES screen by pressing the HOME key, scrolling down to the SETUP menu item and pressing the ENTER  key and then scrolling down to the PREFERENCE menu item and pressing the ENTER  key.
13. Select the AUTO-OFF box and, if necessary, toggle it to its un-checked state by pressing the ENTER  key. This will allow the unit to remain on even when not being actively used.
14. Allow the unit to run until the battery status indicator shows a value of between 1 and 9%. The unit may be used during this discharge period, if desired; but, it should be noted that the battery charge level indicated on the display will not be accurate until the battery level has fallen below 10% capacity. If desired, the unit can be left running and allowed to fully discharged and shut down.

Once the battery level has fallen below 10%, the battery status indicator has been initialized. The external power supply will need to be connected to charge the battery. The unit may be turned on and used during this charge period, if desired

## HELP Screen

To open the HELP screen push the HELP short cut button.



This screen will display the firmware versions of the MPQ analyzer, hardware version, serial number, calibration date as well as the IP address of the analyzer if it is connected to a network.

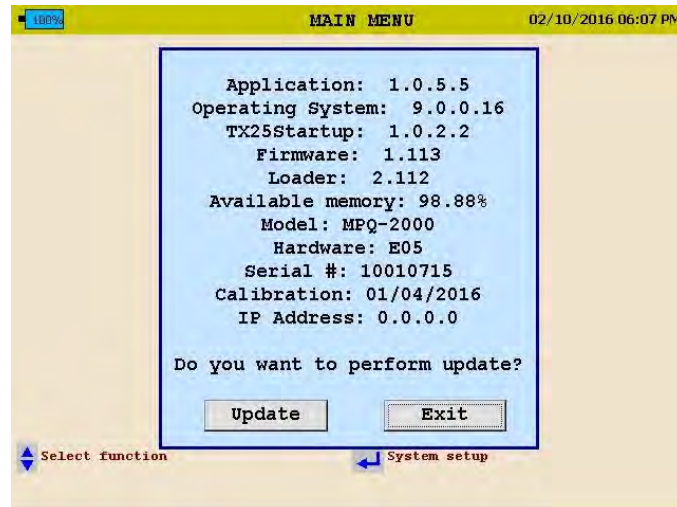

# 13

## Spare Parts

<b>Part No.</b>	<b>Description</b>
2008-369	Battery Pack
JA1009	Current Connector Dust Covers
2006-093	Wire Stand

**Megger.**