

FLUKE®

Calibration

9009

Industrial Dual-Block Calibrator

User's Guide

PN 2673808

February 2013

© 2013 Fluke Corporation. All rights reserved. Specifications are subject to change without notice.

All product names are trademarks of their respective companies.

LIMITED WARRANTY AND LIMITATION OF LIABILITY

Each Fluke product is warranted to be free from defects in material and workmanship under normal use and service. The warranty period is one year and begins on the date of shipment. Parts, product repairs, and services are warranted for 90 days. This warranty extends only to the original buyer or end-user customer of a Fluke authorized reseller, and does not apply to fuses, disposable batteries, or to any product which, in Fluke's opinion, has been misused, altered, neglected, contaminated, or damaged by accident or abnormal conditions of operation or handling. Fluke warrants that software will operate substantially in accordance with its functional specifications for 90 days and that it has been properly recorded on non-defective media. Fluke does not warrant that software will be error free or operate without interruption.

Fluke authorized resellers shall extend this warranty on new and unused products to end-user customers only but have no authority to extend a greater or different warranty on behalf of Fluke. Warranty support is available only if product is purchased through a Fluke authorized sales outlet or Buyer has paid the applicable international price. Fluke reserves the right to invoice Buyer for importation costs of repair/replacement parts when product purchased in one country is submitted for repair in another country.

Fluke's warranty obligation is limited, at Fluke's option, to refund of the purchase price, free of charge repair, or replacement of a defective product which is returned to a Fluke authorized service center within the warranty period.

To obtain warranty service, contact your nearest Fluke authorized service center to obtain return authorization information, then send the product to that service center, with a description of the difficulty, postage and insurance prepaid (FOB Destination). Fluke assumes no risk for damage in transit. Following warranty repair, the product will be returned to Buyer, transportation prepaid (FOB Destination). If Fluke determines that failure was caused by neglect, misuse, contamination, alteration, accident, or abnormal condition of operation or handling, including overvoltage failures caused by use outside the product's specified rating, or normal wear and tear of mechanical components, Fluke will provide an estimate of repair costs and obtain authorization before commencing the work. Following repair, the product will be returned to the Buyer transportation prepaid and the Buyer will be billed for the repair and return transportation charges (FOB Shipping Point).

THIS WARRANTY IS BUYER'S SOLE AND EXCLUSIVE REMEDY AND IS IN LIEU OF ALL OTHER WARRANTIES, EXPRESS OR IMPLIED, INCLUDING BUT NOT LIMITED TO ANY IMPLIED WARRANTY OF MERCHANTABILITY OR FITNESS FOR A PARTICULAR PURPOSE. FLUKE SHALL NOT BE LIABLE FOR ANY SPECIAL, INDIRECT, INCIDENTAL, OR CONSEQUENTIAL DAMAGES OR LOSSES, INCLUDING LOSS OF DATA, ARISING FROM ANY CAUSE OR THEORY.

Since some countries or states do not allow limitation of the term of an implied warranty, or exclusion or limitation of incidental or consequential damages, the limitations and exclusions of this warranty may not apply to every buyer. If any provision of this Warranty is held invalid or unenforceable by a court or other decision-maker of competent jurisdiction, such holding will not affect the validity or enforceability of any other provision.

Fluke Corporation
P.O. Box 9090
Everett, WA 98206-9090
U.S.A.

Fluke Europe B.V.
P.O. Box 1186
5602 BD Eindhoven
The Netherlands

11/99

To register your product online, visit register.fluke.com

Table of Contents

1	Before You Start	1
1.1	Symbols Used	1
1.2	Safety Information	2
1.2.1	WARNINGS	2
1.2.2	CAUTIONS	4
1.3	Authorized Service Centers.	5
2	Introduction	7
3	Specifications and Environmental Conditions	9
3.1	Specifications	9
3.2	Environmental Conditions	9
4	Quick Start	11
4.1	Unpacking	11
4.2	Set-Up	11
4.3	Power	11
4.4	Setting the Temperature	12
4.5	Changing Display Units	12
5	Parts and Controls	13
5.1	Top Panel (Lid Open)	13
5.2	Constant Temperature Block Assembly	14
5.2.1	Constant Temperature Block	14
5.3	Accessories	15
6	General Operation	17
6.1	Changing Display Units	17
7	Controller Operation	19
7.1	Well Temperature	19
7.2	Temperature Set-point	19
7.2.1	Programmable Set-points	19
7.2.2	Set-point Value	21
7.2.3	Temperature Scale Units	21
7.3	Scan	22
7.3.1	Scan Control	22

7.3.2	Scan Rate	22
7.4	Secondary Menu.	23
7.5	Heater Power	23
7.6	Proportional Band	23
7.7	Controller Configuration	25
7.8	Operating Parameters	25
7.9	Serial Interface Parameters	25
7.9.1	BAUD Rate	26
7.9.2	Sample Period.	26
7.9.3	Duplex Mode	26
7.9.4	Linefeed.	27
7.10	Calibration Parameters	27
7.10.1	R0	28
7.10.2	ALPHA	28
7.10.3	DELTA	28
7.10.4	BETA (Low Temp Only)	28
8	Digital Communication Interface	29
8.1	Serial Communications	29
8.1.1	Wiring	29
8.1.2	Setup	30
8.1.2.1	Baud Rate	30
8.1.2.2	Sample Period.	30
8.1.2.3	Duplex Mode	30
8.1.2.4	Linefeed.	30
8.1.3	Serial Operation.	31
8.2	Interface Commands	31
9	Test Probe Calibration	35
9.1	Calibrating a Single Probe.	35
9.2	Calibrator Characteristics	35
9.2.1	Stabilization and Accuracy	35
10	Calibration Procedure	37
10.1	Calibration Points	37
10.2	Calibration Procedure	37
10.2.1	Compute DELTA	37
10.2.2	Compute R0 & ALPHA.	38
10.2.3	Compute BETA (Cold Side Only)	38
10.2.4	Accuracy & Repeatability.	39
11	Maintenance	41
12	Troubleshooting.	43

12.1	Troubleshooting	43
12.2	Comments	43
12.2.1	EMC Directive	43
12.2.2	Low Voltage Directive (Safety).	44

Figures

Figure 1	Top Panel (Lid Open)	13
Figure 2	Constant Temperature Block Assembly	15
Figure 3	Controller Operation Flowchart	20
Figure 4	Serial Cable Wiring	29

Tables













Table 1	International Electrical Symbols	1
Table 2	9009 Controller Communications Commands	32
Table 2	9009 Communication Commands Continued	33



1 Before You Start

1.1 Symbols Used

Table 1 lists the International Electrical Symbols. Some or all of these symbols may be used on the instrument or in this manual.

Table 1 International Electrical Symbols

Symbol	Description
	AC (Alternating Current)
	AC-DC
	Battery
	CE Complies with European Union Directives
	DC
	Double Insulated
	Electric Shock
	Fuse
	PE Ground
	Hot Surface (Burn Hazard)
	Read the User's Manual (Important Information)
	Off
	On

Symbol	Description
	Canadian Standards Association
CAT II	OVERVOLTAGE (Installation) CATEGORY II, Pollution Degree 2 per IEC1010-1 refers to the level of Impulse Withstand Voltage protection provided. Equipment of OVERVOLTAGE CATEGORY II is energy-consuming equipment to be supplied from the fixed installation. Examples include household, office, and laboratory appliances.
	C-TIC Australian EMC Mark
	The European Waste Electrical and Electronic Equipment (WEEE) Directive (2002/96/EC) mark.

1.2 Safety Information

Use this instrument only as specified in this manual. Otherwise, the protection provided by the instrument may be impaired.

The following definitions apply to the terms “Warning” and “Caution”.

- “WARNING” identifies conditions and actions that may pose hazards to the user.
- “CAUTION” identifies conditions and actions that may damage the instrument being used.

1.2.1 WARNINGS



DISCLAIMER: *Hart Scientific manufactures instruments for the purpose of temperature calibration. Instruments used for applications other than calibration are used at the discretion and sole responsibility of the customer. Hart Scientific cannot accept any responsibility for the use of instruments for any application other than temperature calibration.*

GENERAL

DO NOT use the instrument for any application other than calibration work. The instrument was designed for temperature calibration. Any other use of the unit may cause unknown hazards to the user.

DO NOT use the unit in environments other than those listed in the user’s guide.

Completely unattended operation is not recommended.

Follow all safety guidelines listed in the user’s manual.

Calibration Equipment should only be used by Trained Personnel.

If this equipment is used in a manner not specified by the manufacturer, the protection provided by the equipment may be impaired or safety hazards may arise.

Inspect the instrument for damage before each use. **DO NOT** use the instrument if it appears damaged or operates abnormally.

Before initial use, or after transport, or after storage in humid or semi-humid environments, or anytime the instrument has not been energized for more than 10 days, the instrument needs to be energized for a “dry-out” period of 2 hours before it can be assumed to meet all of the safety requirements of the IEC 1010-1. If the product is wet or has been in a wet environment, take necessary measures to remove moisture prior to applying power such as storage in a low humidity temperature chamber operating at 50°C for 4 hours or more.

The instrument is intended for indoor use only.

The instrument has a built-in carrying case. Ensure the carrying case is closed securely and the latches are securely in place when lifting the instrument. Lift the instrument by the handle provided to move the instrument. **DO NOT** close the case and move the instrument until the display reads less than 100°C (212°F).

BURN HAZARD

ALWAYS ensure the instrument is **COOL** before closing the instrument for storage.

DO NOT touch the well access surface of the unit.

- The temperature of the well access is the same as the actual temperature shown on the display, e.g. if the unit is set at 350°C and the display reads 350°C, the well is at 350°C.
- Ensure the power cord is positioned in such a way as it cannot contact hot surfaces or temperature probes. Always inspect power cord before use for any damage to the insulation due to contact with hot surfaces, cuts or abrasions.
- The top sheet metal of the instrument may exhibit extreme temperatures for areas close to the well access.
- **DO NOT** turn off the unit at temperatures higher than 100°C. This could create a hazardous situation. Select a set-point less than 100°C and allow the unit to cool before turning it off.
- **DO NOT** remove inserts at high temperatures. Inserts will be the same temperature as the display temperature. Use extreme care when removing hot inserts,

DO NOT operate near flammable materials. Extreme temperatures could ignite the flammable material.

Use of this instrument at **HIGH TEMPERATURES** for extended periods of time requires caution.

ELECTRICAL HAZARD

These guidelines must be followed to ensure that the safety mechanisms in this instrument will operate properly. This instrument must be plugged into a 115 VAC ($\pm 10\%$) or 230 VAC ($\pm 10\%$) 50/60 Hz only electric outlet as indicated on the serial label. The power cord of the instrument is equipped with a three-pronged grounding plug for your protection against electrical shock hazards. It must be plugged directly into a properly grounded three-prong receptacle. The receptacle must be installed in accordance with local codes and ordinances or adapter plug. **DO NOT** use an extension cord. Consult a qualified electrician. Always inspect the power cord before use for any damage to the insulation due to contact with hot surfaces, cuts or abrasions.

The instrument is equipped with operator accessible fuses. If a fuse blows, it may be due to a power surge or failure of a component. Replace the fuse once. If the fuse blows a second time, it is likely caused by failure of a component part. If this occurs, contact a Hart Scientific Authorized Service Center. Always replace the fuse with one of the same rating, voltage, and type. Never replace the fuse with one of a higher current rating.

Always replace the power cord with an approved cord of the correct rating and type. If you have questions, contact a Hart Scientific Authorized Service Center (see Section 1.3).

High voltage is used in the operation of this equipment. **Severe injury or death** may result if personnel fail to observe the safety precautions.

The block vent cover may be hot due to the fan blowing upward.

1.2.2



CAUTIONS

Always operate this instrument at room temperatures as specified in Section 3.2, Environmental Conditions. Allow sufficient air circulation by leaving at least 6 inches (15 cm) of clearance around the instrument.

Overhead clearance is required. **DO NOT** place this instrument under a cabinet or other structure.

DO NOT use fluids to clean out the well. Fluids could leak into and damage the instrument.

Never introduce any foreign material into the probe hole of the insert. Fluids, etc. can leak into the instrument causing damage.

DO NOT change the values of the calibration constants from the factory set values. The correct setting of these parameters is important to the safety and proper operation of the unit.

DO NOT slam the probe stems into the well. This type of action can cause a shock to the sensor and affect the calibration.

DO use a ground fault interrupt device.

DO NOT operate this instrument in an excessively wet, oily, dusty, or dirty environment.

The unit is a precision instrument. Although it has been designed for optimum durability and trouble free operation, it must be handled with care.

Most probes have handle temperature limits. Be sure that the probe handle temperature limit is not exceeded in the air above the instrument.

The instrument and any thermometer probes used with it are sensitive instruments that can be easily damaged. Always handle these devices with care. Do not allow them to be dropped, struck, stressed, or overheated.

When calibrating PRTs always follow correct calibration procedure and calibrate from high temperatures to low temperatures with the appropriate triple point of water checks.

Components and heater lifetimes can be shortened by continuous high temperature operation.

If a mains supply power fluctuation occurs, immediately turn off the furnace. Power bumps from brown-outs and black-outs can damage the instrument. Wait until the power has stabilized before re-energizing the furnace.

The probe and the block may expand at different rates. Allow for probe expansion inside the well as the block heats. Otherwise, the probe may become stuck in the well.

1.3 **Authorized Service Centers**

Please contact one of the following authorized Service Centers to coordinate service on your Hart product:

Fluke Corporation, Hart Scientific Division

799 E. Utah Valley Drive
American Fork, UT 84003-9775
USA

Phone: +1.801.763.1600
Telefax: +1.801.763.1010
E-mail: support@hartscientific.com

Fluke Nederland B.V.

Customer Support Services
Science Park Eindhoven 5108
5692 EC Son
NETHERLANDS

Phone: +31-402-675300
Telefax: +31-402-675321
E-mail: ServiceDesk@fluke.nl

Fluke Int'l Corporation

Service Center - Instrimpex
Room 2301 Sciteck Tower
22 Jianguomenwai Dajie
Chao Yang District
Beijing 100004, PRC
CHINA

Phone: +86-10-6-512-3436
Telefax: +86-10-6-512-3437
E-mail: xingye.han@fluke.com.cn

Fluke South East Asia Pte Ltd.

Fluke ASEAN Regional Office
Service Center
60 Alexandra Terrace #03-16
The Comtech (Lobby D)
118502
SINGAPORE

Phone: +65 6799-5588
Telefax: +65 6799-5588
E-mail: antng@singa.fluke.com

When contacting these Service Centers for support, please have the following information available:

- Model Number
- Serial Number
- Voltage
- Complete description of the problem

2 Introduction

The Hart Scientific 9009 Industrial Dual-Block Calibrator may be used as a portable instrument or bench top temperature calibrator for calibrating thermocouple and RTD temperature probes. The 9009 is small enough to use in the field, and accurate enough to use in the lab. Calibrations may be done over a range of -15°C to 350°C (5°F to 622°F). Temperature display resolution of the 9009 is 0.1 degrees.

The dry-well calibrator features:

- Two independently controlled temperature blocks
- Rapid heating and cooling
- Interchangeable multiple hole probe sleeves
- Convenient integrated carrying case
- RS-232 interface

Built in programmable features include (applicable to both the hot and cold blocks):

- Temperature scan rate control
- Eight set-point memory
- Adjustable readout in $^{\circ}\text{C}$ or $^{\circ}\text{F}$

The temperature of each well is accurately controlled by a precision Hart Scientific controller. The controller uses a precision platinum RTD as a sensor and controls the hot temperature block with a solid state relay (triac) driven heater. A thermal electric device (TED) controls the cold temperature block.

The LED front panel continuously shows the current well temperature. The temperature may be easily set with the control buttons to any desired temperature within the specified range. The calibrator's multiple fault protection devices insure user and instrument safety and protection.

Note: When one of the temperature blocks is being accessed through the front panel, the other temperature block control panel is not accessible. Always press the "EXIT" button to exit the control panel being used.

The 9009 calibrator was designed for portability, low cost, and ease of operation. Through proper use, the instrument will provide continued accurate calibration of temperature sensors and devices. The user should be familiar with the safety guidelines and operating procedures of the calibrator as described in the instruction manual.

3 Specifications and Environmental Conditions

3.1 Specifications

Specification	Hot Block	Cold Block
Range	50°C to 350°C (122°F to 662°F)	-15°C to 110°C (5°F to 230°F) [-8°C (17°F) to 110°C (230°F) when hot block is at 350°C(662°F)]
Accuracy (Ambient at 23°C ±5°C)	±0.6°C	±0.2°C
Stability†	±0.1°C from 50°C to 100°C ±0.05°C > 100°C	±0.05°C
Well-to-Well Uniformity	±0.1°C	
Display Resolution	0.1°	
Heating Times‡	30 minutes from 25°C to 350°C	15 minutes from 25°C to 110°C
Cooling Times‡	40 minutes from 350°C to 100°C	16 minutes from 25°C to -15°C
Stabilization Times	8 minutes	
Well Depth	4 inches(102 mm)	
Removable Inserts	Two 1/4"(6.4mm) and 3/16"(4.8mm) inserts included – other inserts available	
Power	115 VAC (±10%), 50/60 Hz, 3 A, 250 W [optionally 230 VAC (±10%), 50/60 Hz, 1.6 A, 250 W]	
Heater	135 W	40 W TED
Cooling	Fan	40 W TED
Size	7"H x 10.5"W x 9.75"D (178 x 267 x 248 mm)	
Weight	10 lb (4.5 kg)	
Safety	OVER VOLTAGE (Installation) CATEGORY II, Pollution Degree 2 per IEC1010-1	

†Stability is two times the standard deviation.

‡Heating and cooling times may be affected by line voltages and ambient temperatures.

3.2 Environmental Conditions

Although the instrument has been designed for optimum durability and trouble-free operation, it must be handled with care. The instrument should not be operated in an excessively dusty or dirty environment. Maintenance and cleaning recommendations can be found in the Maintenance Section of this manual.

The instrument operates safely under the following conditions:

- ambient temperature range: 5 - 45°C (41 - 113°F)

- ambient relative humidity: maximum 80% for temperature <31°C, decreasing linearly to 50% at 40°C
- pressure: 75kPa - 106kPa
- mains voltage within $\pm 10\%$ of nominal
- vibrations in the calibration environment should be minimized
- altitudes less than 2,000 meters
- indoor use only

4 Quick Start

4.1 Unpacking

Unpack the calibrator carefully and inspect it for any damage that may have occurred during shipment. If there is shipping damage, notify the carrier immediately.

Verify that the following components are present:

- 9009 Dry-well
- Two 3102-3 (3/16”) and two 3102-4 (1/4”) Inserts
- Power Cord
- Report of Calibration with calibration label
- User’s Guide
- 9930 Interface-it Software and User’s Guide
- RS-232 Cable
- Insert Removal Tool

4.2 Set-Up

Place the calibrator on a flat surface with at least 18 inches above the instrument. Plug the power cord into a grounded mains outlet. Observe that the nominal voltage corresponds to that indicated on the calibrator.

Carefully insert the probe sleeves into the wells. (DO NOT drop the sleeve in the well.) Probe sleeve holes should be of the smallest diameter possible while still allowing the probe to slide in and out easily. Sleeves with various hole sizes are available from Hart Scientific. The well must be clear of any foreign objects, dirt and grit before the sleeve is inserted. The sleeve is inserted with the small tong hole positioned upward.

Turn on the power to the calibrator by toggling the switch on the power entry module. The fan should begin quietly blowing air through the instrument and the controller displays should illuminate after 3 seconds. After a brief self test the controller should begin normal operation. If the unit fails to operate please check the power connection.

The displays will begin to show the well temperature and the well heater and TEDs will start operating to bring the temperature of the wells to the set-point temperatures.

4.3 Power

Plug the calibrator power cord into a mains outlet of the proper voltage, frequency, and current capability. Refer to Section 3.1, Specifications, for power

requirements. Turn the calibrator on using the “POWER” switch on the power entry module (PEM). The calibrator will turn on and begin to heat or cool to the previously programmed temperature set-point. The front panel LED displays will indicate the actual calibrator temperature.

4.4 Setting the Temperature

Section 7.2 explains in detail how to set the temperature set-point on the calibrator using the front panel keys. The procedure is summarized here.

- (1) Press “SET” twice to access the set-point value.
- (2) Press “UP” or “DOWN” to change the set-point value.
- (3) Press “SET” to store the new set-point.
- (4) Press “EXIT” to return to the temperature display.

When the set-point temperature is changed the controller will switch the well heater on or off to raise or lower the temperature. The displayed well temperature will gradually change until it reaches the set-point temperature. The well may require 5 to 10 minutes to reach the set-point depending on the span. Another 5 to 10 minutes is required to stabilize within $\pm 0.1^{\circ}\text{C}$ of the set-point. Ultimate stability may take 15 to 20 minutes more of stabilization time.

4.5 Changing Display Units

The 9009 can display temperature in Celsius or Fahrenheit. The instrument is shipped from the factory set to Celsius. To change to Fahrenheit or back to Celsius perform the following:

1. Press the “SET” and “UP” button simultaneously. The temperature displays the converted temperature and units.

Or

1. Press the “SET” button three times.
2. Press the “UP” or “DOWN” buttons to change the units.
3. Press the “SET” button to store the change.

5 Parts and Controls

The user should become familiar with the dry-well calibrator and its parts.

5.1 Top Panel (Lid Open)

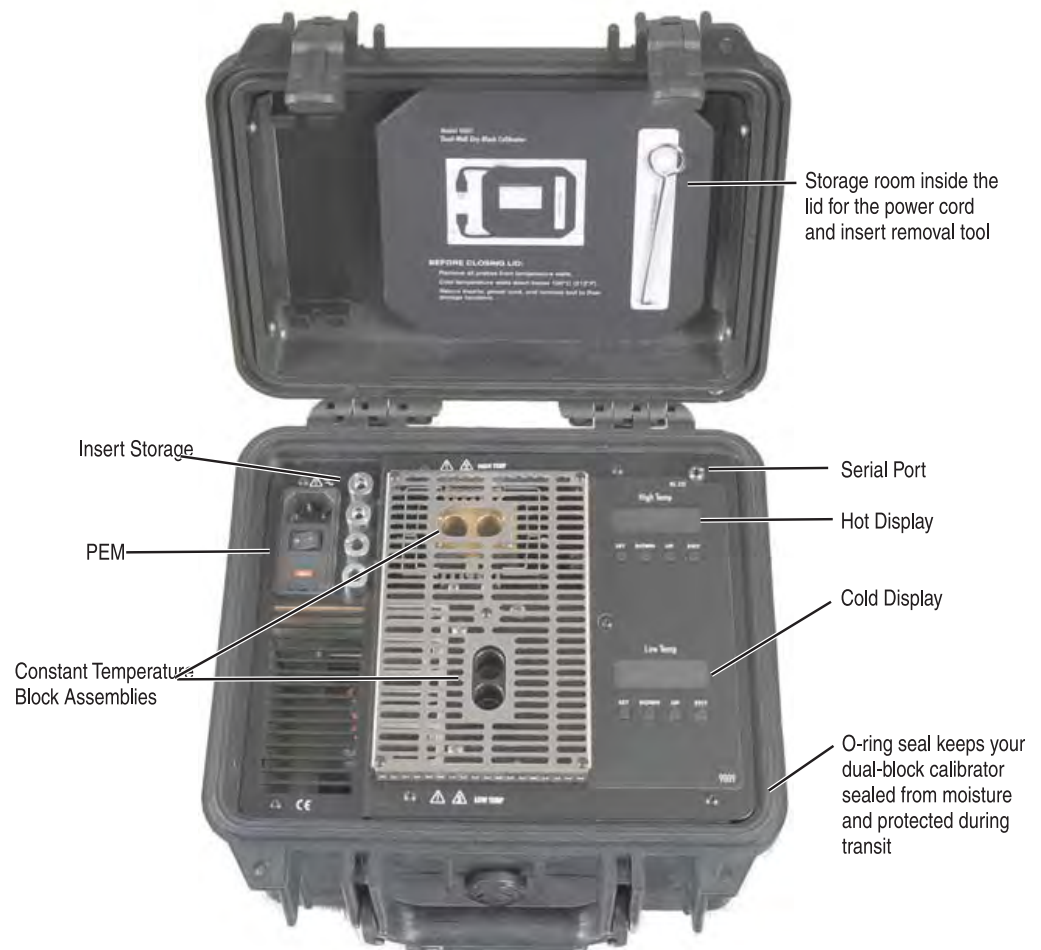

Figure 1 Top Panel (Lid Open)

Power Switch - The power switch is located on the power entry module (PEM). The PEM also houses the fuse.

Power Cord - The removable power cord inlet plugs into an IEC grounded socket on the PEM.

Insert Storage - Four inserts may be stored here.

Constant Temperature Block Assembly - Calibrate two sensors at once or use one well for a reference thermometer. See Section 5.2 for additional details.

Serial Port - A three-conductor jack is present for interfacing the calibrator to a computer or terminal with serial RS-232 communications.

Controller Display - The digital display is an important part of the temperature controller because it not only displays set and actual temperatures but also various calibrator functions, settings, and constants. The display shows temperatures in units according to the selected scale °C or °F. The High Temp and Low Temp displays are labeled.

Controller Keypad - The four button keypad allows easy setting of the set-point temperature. The control buttons (SET, DOWN, UP, and EXIT) are used to set the calibrator temperature set-point, access and set other operating parameters, and access and set calibration parameters. The High Temp and Low Temp controllers each have their own set of buttons.

Setting the control temperature is done directly in degrees of the current scale. It can be set to one-tenth of a degree Celsius or Fahrenheit.

The functions of the buttons are as follows:

SET – Used to display the next parameter in the menu and to store parameters to the displayed value.

DOWN – Used to decrement the displayed value of parameters.

UP – Used to increment the displayed value.

EXIT – Used to exit a function and skip to the next function. Any changes made to the displayed value are ignored.

5.2 Constant Temperature Block Assembly

5.2.1 Constant Temperature Block

The high temperature “Block” is made of bronze and the cold temperature “Block” is made of aluminum. The “Block” provides a constant and accurate temperature environment for the sensor that is to be calibrated (see Figure 2). A 0.5” diameter well is provided that may be used for sensors of that size or may be sleeved down with various sized probe sleeves. Heaters are strategically placed in the block assembly to provide even heat to the sensor. A high-temperature platinum control RTD is imbedded at the base of the block assembly to sense and control the temperature of the block. The entire assembly is suspended in an air cooled chamber thermally isolated from the chassis and electronics.



WARNING: *The block vent cover may be very hot due to the fan blowing upward.*

5.3 Accessories

The following inserts are available for the 9009 calibrator. Inserts may be used with either the hot or cold temperature wells.

Calibration Wells

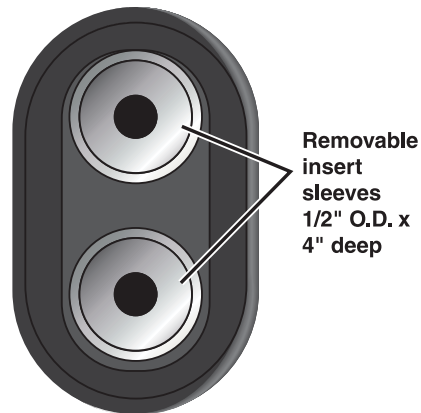

Figure 2 Constant Temperature Block Assembly

Model	Description
3102-0	Blank Insert
3102-1	1/16" (1.6 mm) Insert
3102-2	1/8" (3.2 mm) Insert
3102-3	3/16" (4.8 mm) Insert
3102-4	1/4" (6.4 mm) Insert
3102-5	5/16" (7.9 mm) Insert
3102-6	3/8" (9.5 mm) Insert
3102-7	7/16" (11.1 mm) Insert
3102-8	5/32" (4.0 mm) Insert

6 General Operation

6.1 Changing Display Units

The 9009 can display temperature in Celsius or Fahrenheit. The temperature units are shipped from the factory set to Celsius. To change to Fahrenheit or back to Celsius there are two ways:

1-Press the “SET” and “UP” simultaneously. This will change display units.

Or

1-Press the “SET” button three times from the temperature display to show

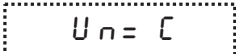
 U n = C

2-Press the “UP” or “DOWN” button to change units.

3-Press “SET” to store changes.

7 Controller Operation

This chapter discusses in detail how to operate the calibrator temperature controller using the front control panel. Using the front panel key-switches and LED display the user may monitor the well temperature, set the temperature set-point in degrees C or F, monitor the heater output power, adjust the controller proportional band, and program the calibration parameters, operating parameters, and serial interface configuration. Operation of the functions and parameters are shown in the flowchart in Figure 3 on page 20. This chart may be copied for reference.

In the following discussion a button with the word SET, UP, EXIT or DOWN inside indicates the panel button while the dotted box indicates the display reading. Explanation of the button or display reading are to the right of each button or display value.

Note: When using one set of control buttons, the other set is disabled.

7.1 Well Temperature

The digital LED display on the front panel allows direct viewing of the actual well temperature. This temperature value is what is normally shown on the display. The units, C or F, of the temperature value are displayed at the right. For example,

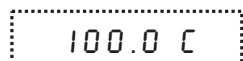

Well temperature in degrees Celsius

The temperature display function may be accessed from any other function by pressing and holding the “EXIT” button.

7.2 Temperature Set-point

The temperature set-point can be set to any value within the range and resolution as given in the specifications. Be careful not to exceed the safe upper temperature limit of any device inserted into the well.

Setting the temperature involves two steps: (1) selecting the set-point memory and (2) adjusting the set-point value.

7.2.1 Programmable Set-points

The controller stores 8 set-point temperatures in memory. The set-points can be quickly recalled to conveniently set the calibrator to a previously programmed temperature set-point.

To set the temperature one must first select the set-point memory. This function is accessed from the temperature display function by pressing “SET”. The number of the set-point memory currently being used is shown at the left on the display followed by the current set-point value.

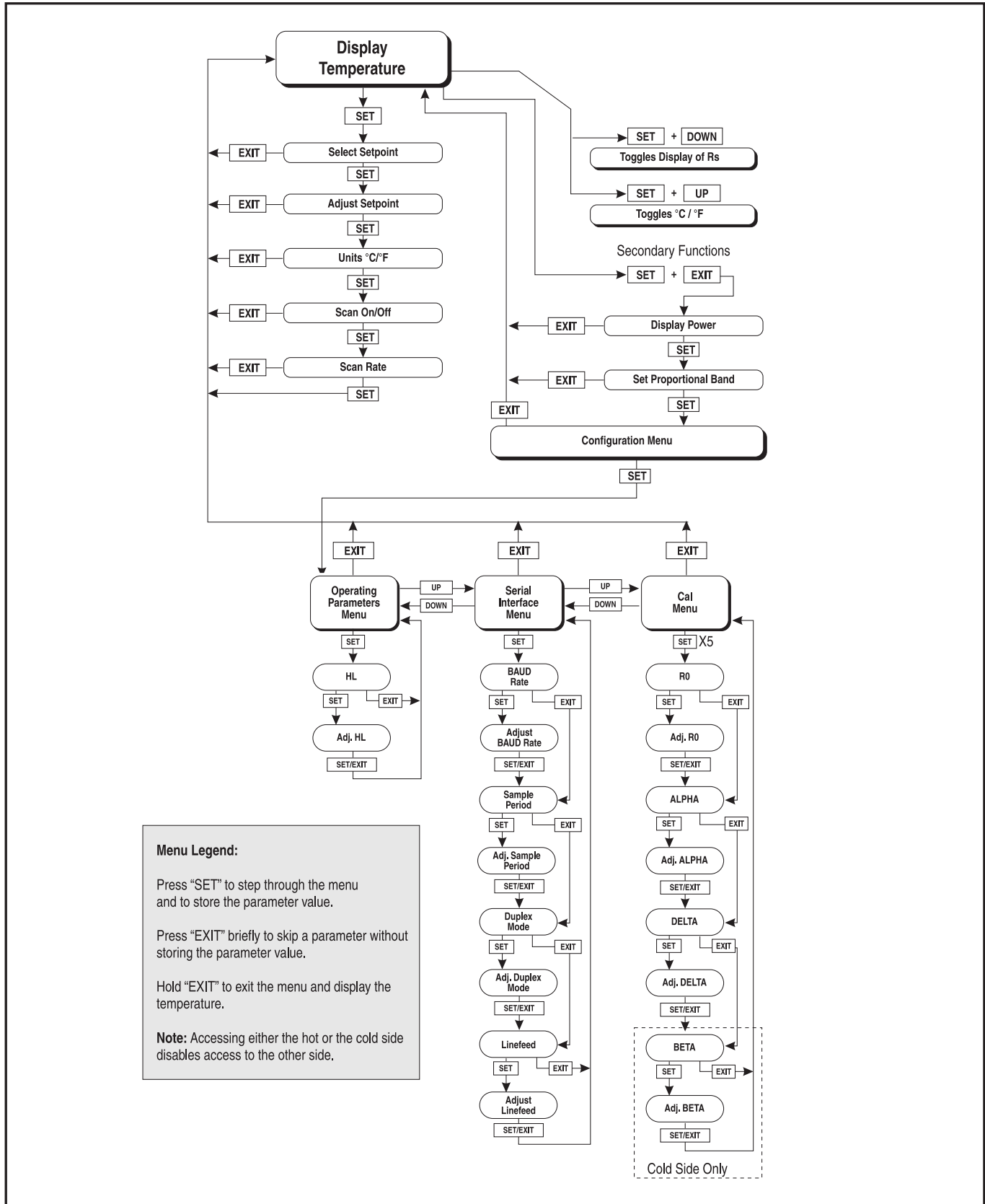



Figure 3 Controller Operation Flowchart

 Well temperature in degrees Celsius

 Access set-point memory

 Set-point memory 1, 100°C currently used

To change to another set-point memory press “UP” or “DOWN”.

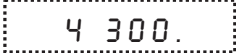
 New set-point memory 4, 300°C

Press “SET” to accept the new selection and access the set-point value.

 Accept selected set-point memory

7.2.2 Set-point Value

The set-point value may be adjusted after selecting the set-point memory and pressing “SET”.

 Set-point 4 value in°C

If the set-point value is correct then press “EXIT” to resume displaying the well temperature. To change the set-point values, press “SET” and then press “UP” or “DOWN” to adjust the set-point value.

 New set-point value

When the desired set-point value is reached press “SET” to accept the new value and access the temperature scale units selection. If “EXIT” is pressed instead then any changes made to the set-point will be ignored.

 Accept new set-point value

7.2.3 Temperature Scale Units

The temperature scale units of the controller maybe set by the user to degrees Celsius (°C) or Fahrenheit (°F). The units are used in displaying the well temperature, set-point, and proportional band.

Press “SET” after adjusting the set-point value to change display units.

 Scale units currently selected

Press “UP” or “DOWN” to change the units.

 *New units selected*

Press “SET” to accept the present setting and to continue.

7.3 Scan

The scan rate can be set and enabled so that when the set-point is changed the calibrator heats or cools at a specified rate (degrees per minute) until it reaches the new set-point. With the scan disabled the calibrator heats or cools at the maximum possible rate.

7.3.1 Scan Control

The scan is controlled with the scan on/off function that appears in the main menu after the temperature scale units.

 *Scan function off*

Press “UP” or “DOWN” to toggle the scan on or off.

 *Scan function on*

Press “SET” to accept the present setting and to continue.

 *Accept scan setting*

7.3.2 Scan Rate

The next function in the main menu is the scan rate. The scan rate can be set from .1 to 99.9°C/min. The maximum scan rate however is actually limited by the natural heating or cooling rate of the instrument. This is often less than 100°C/min, especially when cooling.

The scan rate function appears in the main menu after the scan control function. The scan rate units are in degrees per minute, degrees C or F depending on the selected units.

 *Scan rate in°C/min*

Press “UP” or “DOWN” to change the scan rate.

 *New scan rate*

Press “SET” to accept the new scan rate and continue.

 *Accept scan rate*

7.4 Secondary Menu

Functions which are used less often are accessed within the secondary menu. The secondary menu is accessed by pressing “SET” and “EXIT” simultaneously and then releasing. The first function in the secondary menu is the heater power display. (See Figure 3 on page 20.)

7.5 Heater Power

The temperature controller controls the temperature of the well by pulsing the heater on and off. The total power being applied to the heater is determined by the duty cycle or the ratio of heater on time to the pulse cycle time. By knowing the amount of heating the user can tell if the calibrator is heating up to the set-point, cooling down, or controlling at a constant temperature. Monitoring the percent heater power will let the user know how stable the well temperature is. With good control stability the percent heating power should not fluctuate more than $\pm 1\%$ within one minute.

Note: For the Cold Side, negative numbers indicate the well is being cooled. When the display reads, -100 P , the well is being cooled at maximum power. When the display reads, 0 P , the well is neither heating nor cooling. When the display reads, 100 P , the well is being heated at maximum power.

For the hot side, when the display reads, 0 P , maximum cooling is occurring (no heater power is applied). The power percentage is never negative on the hot side.

The heater power display is accessed in the secondary menu. Press “SET” and “EXIT” simultaneously and release. The heater power will be displayed as a percentage of full power.

 Well temperature

 Access heater power in secondary menu

 Flashes 5 E C for secondary menu and then displays the heater power

 Heater power in percent

To exit out of the secondary menu press and hold “EXIT”. To continue on to the proportional band setting function press “SET”.

7.6 Proportional Band

In a proportional controller such as this the heater output power is proportional to the well temperature over a limited range of temperatures around the

set-point. This range of temperature is called the proportional band. At the bottom of the proportional band the heater output is 100%. At the top of the proportional band the heater output is 0. Thus as the temperature rises the heater power is reduced, which consequently tends to lower the temperature back down. In this way the temperature is maintained at a fairly constant temperature.

The temperature stability of the well and response time depend on the width of the proportional band. If the band is too wide the well temperature deviates excessively from the set-point due to varying external conditions. This is because the power output changes very little with temperature and the controller cannot respond very well to changing conditions or noise in the system. If the proportional band is too narrow the temperature may swing back and forth because the controller overreacts to temperature variations. For best control stability the proportional band must be set for the optimum width.

The proportional band width is set at the factory. The proportional band width may be altered by the user if he desires to optimize the control characteristics for a particular application.

The proportional band width is easily adjusted from the front panel. The width may be set to discrete values in degrees C or F depending on the selected units. The proportional band adjustment is accessed within the secondary menu. Press “SET” and “EXIT” to enter the secondary menu and show the heater power. Then press “SET” to access the proportional band.



Access heater power in secondary menu



Flashes 5 E C for secondary menu and then displays the heater power

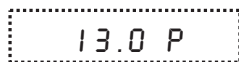

Heater power in percent



Access proportional band



Flashes P r o P and then displays the current setting

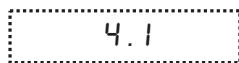

Current proportional band setting

To change the proportional band press “UP” or “DOWN”.

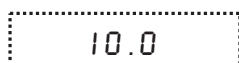

New proportional band setting

To accept the new setting press “SET”. Press “EXIT” to continue without storing the new value.



Accept the new proportional band setting

7.7 Controller Configuration

The controller has a number of configuration and operating options and calibration parameters which are programmable via the front panel. These are accessed from the secondary menu after the proportional band function by pressing “SET”. The display flashes “CONF” and then displays “PAR” for the first of three sets of configuration parameters — operating parameters, serial interface parameters, and calibration parameters. The sets are selected using the “UP” and “DOWN” keys and then pressing “SET” (see Figure 3 on page 20).

7.8 Operating Parameters

The operating parameters menu is indicated by,



Operating parameters menu

Press “SET” to enter the menu. The operating parameters menu contains the HL (High Limit) parameter. The HL parameter adjusts the upper set-point temperature. The factory default and maximum are set to 350°C. For safety, a user can adjust the HL down so the maximum temperature set-point is restricted.

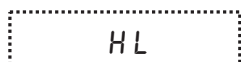

Flashes HL and then displays the current value

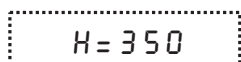

Current HL setting

Adjust the HL parameter using “UP” or “DOWN”.

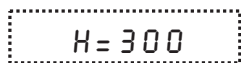

New HL setting

Press “SET” to accept the new temperature limit.

7.9 Serial Interface Parameters

The serial RS-232 interface parameters menu is indicated by,

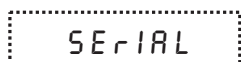

Serial RS-232 interface parameters menu

The serial interface parameters menu contains parameters which determine the operation of the serial interface. These controls only apply to instruments fitted with the serial interface. The parameters in the menu are — BAUD rate, sample period, duplex mode, and linefeed. Press “SET” to enter the menu.

7.9.1 BAUD Rate

The BAUD rate is the first parameter in the menu. The BAUD rate setting determines the serial communications transmission rate.

`BAUD` *Flashes BAUD and then displays the current setting*

`2400 b` *Current BAUD rate setting*

The BAUD rate of the serial communications may be programmed to 300, 600, 1200, **2400 (default)**, 4800, or 9600 BAUD. Use “UP” or “DOWN” to change the BAUD rate value.

`4800 b` *New BAUD rate*

Press “SET” to set the BAUD rate to the new value or “EXIT” to abort the operation and skip to the next parameter in the menu.

7.9.2 Sample Period

The sample period is the next parameter in the serial interface parameter menu. The sample period is the time period in seconds between temperature measurements transmitted from the serial interface. If the sample rate is set to 5, the instrument transmits the current measurement over the serial interface approximately every five seconds. The automatic sampling is disabled with a sample period of 0.

`SPEr` *Flashes SPEr and then displays the current setting*

`SP= 1` *Current sample period (seconds) setting*

Adjust the value with “UP” or “DOWN” and then use “SET” to set the sample rate to the displayed value.

`SP= 60` *New sample period*

7.9.3 Duplex Mode

The next parameter is the duplex mode. The duplex mode may be set to full duplex or half duplex. With full duplex any commands received by the calibrator via the serial interface are immediately echoed or transmitted back to the device of origin. With half duplex the commands are executed but not echoed.

`dUPL` *Flashes dUPL and then displays the current setting*

`d=FULL` *Current duplex mode setting*

The mode may be changed using “UP” or “DOWN” and pressing “SET”.

`d = H R L F` *New duplex mode setting*

7.9.4 Linefeed

The final parameter in the serial interface menu is the linefeed mode. This parameter enables (on) or disables (off) transmission of a linefeed character (LF, ASCII 10) after transmission of any carriage-return.

`LF` *Flashes LF and then displays the current setting*

`LF = On` *Current linefeed setting*

The mode may be changed using “UP” or “DOWN” and pressing “SET”.

`LF = OFF` *New linefeed setting*

7.10 Calibration Parameters

The operator of the instrument controller has access to a number of the calibration constants namely R0, ALPHA, DELTA, and BETA (cold side only). These values are set at the factory and must not be altered. The correct values are important to the accuracy and proper and safe operation of the instrument. Access to these parameters is available to the user so that in the event that the controller memory fails the user may restore these values to the factory settings. These constants and their settings are on the Report of Calibration that is shipped with the instrument.



CAUTION: *DO NOT change the values of the instrument's calibration constants from the factory set values. The correct setting of these parameters is important to the safety and proper operation of the instrument.*

The calibration parameters menu is indicated by,

`CAL` *Calibration parameters menu*

Press “SET” five times to enter the menu. The calibration parameters menu contains the parameters, R0, ALPHA, DELTA, and BETA (cold side only) which characterize the resistance-temperature relationship of the platinum control sensor. These parameters may be adjusted to improve the accuracy of the calibrator.

The calibration parameter name flashes on the display and then the current value is displayed. The value of the parameter may be changed using the “UP” and “DOWN” buttons. After the desired value is reached press “SET” to set the

parameter to the new value. Pressing “EXIT” causes the parameter to be skipped ignoring any changes that may have been made.

7.10.1 R0

This probe parameter refers to the resistance of the control probe at 0°C. The value of this parameter is set at the factory for best instrument accuracy.

7.10.2 ALPHA

This probe parameter refers to the average sensitivity of the probe between 0 and 100°C. The value of this parameter is set at the factory for best instrument accuracy.

7.10.3 DELTA

This probe parameter characterizes the curvature of the resistance-temperature relationship of the sensor. The value of this parameter is set at the factory for best instrument accuracy.

7.10.4 BETA (Low Temp Only)

This probe parameter characterizes the low temperatures. The value of this parameter is set at the factory for best instrument accuracy.

8 Digital Communication Interface

The calibrator is capable of communicating with and being controlled by other equipment through the digital serial interface.

With a digital interface the instrument may be connected to a computer or other equipment. This allows the user to set the set-point temperature, monitor the temperature, and access any of the other controller functions, all using remote communications equipment. Communications commands are summarized in Table 2 on page 32.

8.1 Serial Communications

The calibrator is installed with an RS-232 serial interface that allows serial digital communications over fairly long distances. With the serial interface the user may access any of the functions, parameters and settings discussed in Section 7 with the exception of the BAUD rate setting. The protocol for serial communications is eight data bits, one stop bit, no parity, and no flow control.

8.1.1 Wiring

The three-conductor jack for the serial port is located on the top of the instrument. Figure 4 shows the pin-out of this connector. **Note:** The TxD line on one side connects to the RxD line on the other and vice-versa. To reduce the possibility of electrical interference, the serial cable should be shielded with low resistance between the connector and the shield.

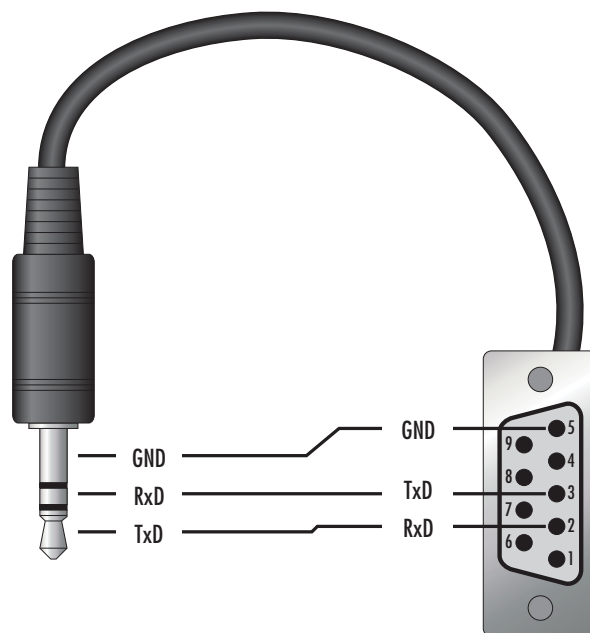

Figure 4 Serial Cable Wiring

8.1.2 Setup

Before operation the serial interface must first be set up by programming the BAUD rate and other configuration parameters. These parameters are programmed within the serial interface menu. The serial interface parameters menu is outlined in Figure 3 on page 20.

To enter the serial parameter programming mode first press "EXIT" while pressing "SET" and release to enter the secondary menu. Press "SET" until the display reads "P A R". Press "UP" until the serial interface menu is indicated with "S E R I A L". Finally press "SET" to enter the serial parameter menu. In the serial interface parameters menu are the BAUD rate, the sample rate, the duplex mode, and the linefeed parameter.

8.1.2.1 Baud Rate

The baud rate is the first parameter in the menu. The display will prompt with the baud rate parameter by showing "B A U D". The current baud rate value is displayed. The baud rate of the 9009 serial communications may be programmed to 300, 600, 1200, 2400, 4800, or 9600 baud. The baud rate is pre-programmed to 2400 baud. Use "UP" or "DOWN" to change the BAUD rate value. Press "SET" to set the BAUD rate to the new value or "EXIT" to abort the operation and skip to the next parameter in the menu.

8.1.2.2 Sample Period

The sample period is the next parameter in the menu and prompted with "S P E R". The sample period is the time period in seconds between temperature measurements transmitted from the serial interface. If the sample rate is set to 5 then the instrument transmits the current measurement over the serial interface approximately every five seconds. The automatic sampling is disabled with a sample period of 0. Adjust the period with "UP" or "DOWN" and then use "SET" to set the sample rate to the displayed value.

8.1.2.3 Duplex Mode

The next parameter is the duplex mode indicated with "D U P L". The duplex mode may be set to half duplex ("H A L F") or full duplex ("F U L L"). With full duplex any commands received by the thermometer via the serial interface are immediately echoed or transmitted back to the device of origin. With half duplex the commands are executed but not echoed. The default setting is full duplex. The mode may be changed using "UP" or "DOWN" and pressing "SET".

8.1.2.4 Linefeed

The final parameter in the serial interface menu is the linefeed mode. This parameter enables ("O N") or disables ("O F F") transmission of a linefeed character (LF, ASCII 10) after transmission of any carriage-return. The default setting is with linefeed on. The mode may be changed using "UP" or "DOWN" and pressing "SET".

8.1.3 Serial Operation

Once the cable has been attached and the interface set up properly the controller immediately begins transmitting temperature readings at the programmed rate. The serial communications uses 8 data bits, one stop bit, and no parity. The set-point and other commands may be sent via the serial interface to set the temperature set-point and view or program the various parameters. The interface commands are discussed in Section 8.2. All commands are ASCII character strings terminated with a carriage-return character (CR, ASCII 13).

8.2 Interface Commands



NOTE: When sending a command, preface the command with either a *C:* (cold side) or *H:* (hot side). If the *C:* or *H:* are left off, the returned value is for the hot side.

The various commands for accessing the calibrator functions via the digital interfaces are listed in this section (see Table 2). These commands are used with the RS-232 serial interface. The commands are terminated with a carriage-return character. The interface makes no distinction between upper and lower case letters, hence either may be used. Commands may be abbreviated to the minimum number of letters which determines a unique command. A command may be used to either set a parameter or display a parameter depending on whether or not a value is sent with the command following a “=” character. For example “s”<CR> returns the current set-point and “s=150.0”<CR> sets the set-point to 150.0 degrees.

In the following list of commands, characters or data within brackets, “[” and “]”, are optional for the command. A slash, “/”, denotes alternate characters or data. Numeric data, denoted by “n”, may be entered in decimal or exponential notation. Characters are shown in lower case although upper case may be used. Spaces may be added within command strings and will simply be ignored. Backspace (BS, ASCII 8) may be used to erase the previous character. A terminating CR is implied with all commands.

Table 2 9009 Controller Communications Commands

Command Description	Command Format†	Command Example‡	Returned	Returned Example	Acceptable Values
Display Temperature					
Read current set-point	s[etpoint]	s	set: 9999.99 {C or F}	set: 150.00 C	
Set current set-point to <i>n</i>	s[etpoint]= <i>n</i>	s=350			Instrument Range
Read temperature	t[emperature]	t	t{h or c}: 9999.99 {C or F}	th: 55.66 C	
Read temperature units	u[nits]	u	u: x	u: C	
Set temperature units:	u[nits]=c/f				C or F
Set temperature units to Celsius	u[nits]=c	u=c			
Set temperature units to Fahrenheit	u[nits]=f	u=f			
Read scan mode	sc[an]	sc	sc: {ON or OFF}	sc: ON	
Set scan mode	sc[an]=on/off	sc=on			ON or OFF
Read scan rate	sr[ate]	sr	srat: 99.9 {C or F}/min	srat:12.4 C/min	
Set scan rate	sr[ate]= <i>n</i>	sr=1.1			0.1 to 99.9
Secondary Menu					
Read proportional band setting	pr[opband]	pr	pb: 999.9	pb: 15.9	
Set proportional band to <i>n</i>	pr[opband]= <i>n</i>	pr=8.83			Depends on Configuration
Read heater power (duty cycle)	po[wer]	po	po: 999.9	po: 1.3	
Configuration Menu					
Operating Parameters Menu					
Read High Limit	hl	hl	hl: 999	hl: 350	
Set High Limit	hl= <i>n</i>	hl=350			Cold 25 to 126, Hot 50 to 350
Serial Interface Menu					
Read serial sample setting	sa[mple]	sa	sa: 9	sa: 1	
Set serial sampling setting to <i>n</i> seconds	sa[mple]= <i>n</i>	sa=0			0 to 999
Set serial duplex mode:	du[plex]=f[ull]/h[alf]				FULL or HALF
Set serial duplex mode to full	du[plex]=f[ull]	du=f			
Set serial duplex mode to half	du[plex]=h[alf]	du=h			
Set serial linefeed mode:	lf[eed]=on/of[f]				ON or OFF
Set serial linefeed mode to on	lf[eed]=on	lf=on			
Set serial linefeed mode to off	lf[eed]=of[f]	lf=of			

9009 Communication Commands Continued

Command Description	Command Format†	Command Example‡	Returned	Returned Example	Acceptable Values
Calibration Parameters Menu					
Read R0 calibration parameter	r[0]	r	r0: 999.999	r0: 100.578	
Set R0 calibration parameter to <i>n</i>	r[0]= <i>n</i>	r=100.324			100 to 105
Read ALPHA calibration parameter	al[pha]	al	al: 9.9999999	al: 0.0038573	
Set ALPHA calibration parameter to <i>n</i>	al[pha]= <i>n</i>	al=0.0038433			0.002 to 0.006
Read DELTA calibration parameter	de[lta]	de	de: 9.9999	de: 1.507	
Set DELTA calibration parameter	de[lta]= <i>n</i>	de=1.3742			0.5 to 1.9
Read BETA calibration parameter	be[ta]	be	Be: 9.999	be:0.342	–25 to 25
Set BETA calibration parameter	be[ta]= <i>n</i>	be=0.342			
Miscellaneous					
Read firmware version number	*ver[sion]	*ver	ver.9999,9.99	ver.9009,1.21	
Read structure of all commands	h[elp]	h	list of commands		
Read ALL operating parameters	all	all	list of parameters		
Legend:	[] Optional Command data				
	{ } Returns either information				
	<i>n</i> Numeric data supplied by user				
	9 Numeric data returned to user				
	<i>x</i> Character data returned to user				
Note:	When DUPLEX is set to FULL and a command is sent to READ, the command is returned followed by a carriage return and linefeed. Then the value is returned as indicated in the RETURNED column.				

†Preface all commands with either C: (for cold side) or H: (for hot side). If the C: or H: is left off, the returned value is for the hot side.

‡The returned command has either a 'C' or an 'H' before the colon depending on which side was queried.

9 Test Probe Calibration

For optimum accuracy and stability, allow the calibrator to warm up for 10 minutes after power-up and then allow adequate stabilization time after reaching the set-point temperature. After completing operation of the calibrator, allow the well to cool by setting the temperature to 25°C for one-half hour before switching the power off.

9.1 Calibrating a Single Probe

Insert the probe to be calibrated into the well of the calibrator. The probe should fit snugly into the calibrator probe sleeve yet should not be so tight that it cannot be easily removed. Avoid any dirt or grit that may cause the probe to jam into the sleeve. Best results are obtained with the probe inserted to the full depth of the well. Once the probe is inserted into the well, allow adequate stabilization time to allow the test probe temperature to settle as described above. Once the probe has settled to the temperature of the well, it may be compared to the calibrator display temperature. The display temperature should be stable to within 0.1°C degree for best results.



CAUTION: *Never introduce any foreign material into the probe hole of the insert. Fluids etc. can leak into the calibrator causing damage to the calibrator or binding and damage to your probe.*

9.2 Calibrator Characteristics

There is a temperature gradient vertically in the test well. The heater has been applied to the block in such a way as to compensate for nominal heat losses out of the top of the calibrator. However, actual heat losses will vary with design of the thermometer probes inserted into the calibrator and the temperature. For best results, insert probe to full depth of well.

9.2.1 Stabilization and Accuracy

The stabilization time of the calibrator depends on the conditions and temperatures involved. Typically the test well will stabilize to 0.1°C within 5 minutes of reaching the set-point temperature as indicated by the display. Ultimate stability is achieved 10 to 20 minutes after reaching the set temperature.

Inserting a cold probe into a well requires another period of stabilizing depending on the magnitude of the disturbance and the required accuracy. For example, inserting a 0.25 inch diameter room temperature probe into a sleeve at 300°C takes 5 minutes to be within 0.1°C of its settled point and takes 10 minutes to achieve maximum stability.

Speeding up the calibration process can be accomplished by knowing how soon to make the measurement. It is recommended that typical measurements be

made at the desired temperatures with the desired test probes to establish these times.

10 Calibration Procedure

Sometimes the user may want to calibrate the instrument to improve the temperature set-point accuracy. Calibration is done by adjusting the controller probe calibration constants R0, ALPHA, DELTA, and BETA (cold side) so that the temperature of the calibrator as measured with a standard thermometer agrees more closely with the set-point. The thermometer used must be able to measure the well temperature with higher accuracy than the desired accuracy of the calibrator. By using a good thermometer and following this procedure the instrument can be calibrated to an accuracy of better than 0.5°C up 100°C.

10.1 Calibration Points

In calibrating the instrument, R0, ALPHA, DELTA, and BETA (cold side) are adjusted to minimize the set-point error at each of three different temperatures. Any three reasonably separated temperatures may be used for the calibration. Improved results can be obtained for shorter ranges when using temperatures that are just within the most useful operating range of the instrument. The farther apart the calibration temperatures, the larger will be the calibrated temperature range but the calibration error will also be greater over the range. If for instance -15°C to 100°C is chosen as the calibration range then the calibrator may achieve an accuracy of ±0.2°C over the range -15 to 100°C. Choosing a range of 50°C to 90°C may allow the calibrator to have a better accuracy than ±0.2°C over that range but outside that range the accuracy may be only ±1.5°C.

10.2 Calibration Procedure

1. Choose four set-points to use in the calibration of the R0, ALPHA, DELTA, and BETA parameters. These set-points are generally -15°C, 0°C, 60°C and 110°C but other set-points may be used if desired or necessary.
2. Set the instrument to the low set-point. When the calibrator reaches the set-point and the display is stable, wait 15 minutes or so and then take a reading. Sample the set-point resistance by holding down the SET key and pressing the DOWN key. Write these values down as T₁ and R₁ respectively.
3. Repeat step 2 for the other two set-points recording them as T₁, R₁, T₂, R₂, T₃, R₃, T₄, and R₄ respectively.
4. Using the recorded data, calculate new values for R0, ALPHA, DELTA, BETA parameters using the equations given below:

10.2.1 Compute DELTA

$$A = T_4 - T_3$$

$$B = T_3 - T_2$$

$$C = \left[\frac{T_4}{100} \right] \left[1 - \frac{T_4}{100} \right] - \left[\frac{T_3}{100} \right] \left[1 - \frac{T_3}{100} \right]$$

$$D = \left[\frac{T_3}{100} \right] \left[1 - \frac{T_3}{100} \right] - \left[\frac{T_2}{100} \right] \left[1 - \frac{T_2}{100} \right]$$

$$E = R_4 - R_3$$

$$F = R_3 - R_2$$

$$\text{delta} = \frac{AF - BE}{DE - CF}$$

Where:

T₁₋₄ - Measured temperature using thermometer.

R₁₋₄ - Value of R from display of 9009 (Press SET and DOWN at the same time.)

where

T₁ and **R₁** are the measured temperature and resistance at -15 °C

T₂ and **R₂** are the measured temperature and resistance at 0 °C

T₃ and **R₃** are the measured temperature and resistance at 60 °C

T₄ and **R₄** are the measured temperature and resistance at 110°C

10.2.2 Compute R0 & ALPHA

$$a_1 = T_2 + \text{delta} \left[\frac{T_2}{100} \right] \left[1 - \frac{T_2}{100} \right]$$

$$a_3 = T_4 + \text{delta} \left[\frac{T_4}{100} \right] \left[1 - \frac{T_4}{100} \right]$$

$$rzero = \frac{R_4 a_1 - R_2 a_3}{a_1 - a_3}$$

$$\text{alpha} = \frac{R_2 - R_4}{R_4 a_1 - R_2 a_3}$$

Where:

delta is the new value of DELTA computed above

10.2.3 Compute BETA (Cold Side Only)

$$x = \left[\frac{T_1}{100} \right] - 1$$

$$y = \left[\frac{T_1}{100} \right]$$

$$beta = \frac{1}{(alpha)(x)(y^3)} + \frac{T_1}{(x)(y^3)} - \frac{delta}{y^2} - \frac{\frac{R_1}{rzero}}{(alpha)(x)(y^3)}$$

Where:

t and r are the measured resistance at -15°C .

alpha, rzero, and delta are the new values of ALPHA, R0, and DELTA calculated above.

Program the new values for DELTA (delta), R0 (rzero), ALPHA (alpha) and BETA (cold side only) into the calibrator with the following steps.

1. Press the “SET” and “EXIT” keys at the same time and then press “SET” until R0 is displayed.
2. Press “SET” then use the “UP” or “DOWN” keys until the correct numerical setting is displayed. Press “SET” to accept the new value.
3. Repeat step 2 for ALPHA, DELTA, and BETA (cold side only).

10.2.4 Accuracy & Repeatability

Check the accuracy of the calibrator at various points over the calibrated range. If instrument does not pass specification at all set-points, repeat the Calibration Procedure.

11 Maintenance

- The calibration instrument has been designed with the utmost care. Ease of operation and simplicity of maintenance have been a central theme in the product development. Therefore, with proper care the instrument should require very little maintenance. Avoid operating the instrument in an oily, wet, dirty, or dusty environment.
- If the outside of the instrument becomes soiled, it may be wiped clean with a damp cloth and mild detergent. Do not use harsh chemicals on the surface which may damage the paint.
- It is important to keep the well of the calibrator clean and clear of any foreign matter. Do not use fluid to clean out the well.
- The calibrator should be handled with care. Avoid knocking or dropping the calibrator.
- The removable probe sleeves can become covered with dust and carbon material. If the buildup becomes too thick, it could cause the sleeves to become jammed in the wells. Avoid this build up by periodically buffing the sleeves clean.
- If a sleeve should be dropped, examine the sleeve for deformities before inserting it in the well. If there is any chance of jamming the sleeve in the well, file or grind off the protuberance.
- Do not slam the probe stems into the well. This type of action can cause a shock to the sensor.
- If a hazardous material is spilt on or inside the equipment, the user is responsible for taking the appropriate decontamination steps as outlined by the national safety council with respect to the material.
- If the mains supply cord becomes damaged, replace it with a cord with the appropriate gauge wire for the current of the instrument. If there are any questions, call an Authorized Service Center for more information.
- Before using any cleaning or decontamination method except those recommended by Hart, users should check with an Authorized Service Center to be sure that the proposed method will not damage the equipment.
- If the instrument is used in a manner not in accordance with the equipment design, the operation of the instrument may be impaired or safety hazards may arise.

12 Troubleshooting

12.1 Troubleshooting

In the event that the dry-well appears to function abnormally, this section may help to find and solve the problem. Several possible problem conditions are described along with likely causes and solutions. If a problem arises please read this section carefully and attempt to understand and solve the problem. If the dry-well seems faulty or the problem cannot otherwise be solved, contact an Authorized Service Center for assistance. Be sure to have the instrument model number, serial number, and voltage available.

Problem	Causes and Solutions
Incorrect temperature reading	Power the unit on and watch the display. If the first number displayed is less than “-0005-”, the unit has been re-initialized. Initialize the system by performing the Master Reset Sequence as described in the problem, <i>Controller locks up</i> .
The display is off	Check the fuses. Check that the power cord is plugged in and connected to the unit.
The unit heats slowly	Check the Scan and Scan Rate settings. The Scan may be on with the Scan Rate set low.
Controller locks up	Initialize the system by performing the Master Reset Sequence . If the unit repeats the error code, contact an Authorized Service Center. Master Reset Sequence: The Master Reset must be performed on the cold side. However, both the cold and the hot sides are reset. Hold the “SET” and “EXIT” keys down (on the cold side) at the same time while powering up the unit. The screen will display “-init-”, the instrument model number, and the version of the software. The unit will need to be reprogrammed on both the hot and the cold side for R0, ALPHA, and DELTA, and on the cold side for BETA in the calibration menu. These numbers can be found on the Report of Calibration that was shipped with the unit.
Temperature readout is not the actual temperature of the well	With the unit stable, slowly rotate the unit. If no change occurs, the unit may need to be calibrated. Contact an Authorized Service Center. If the display changes more than twice the normal display deviation, another unit in the area could be emitting RF energy. Move the unit to a different location and rotate the unit again. If the temperature is correct in this new area or deviates differently than the first area, RF energy is present in the room. If you have to perform the test in the effected area, use the comparison test to eliminate any possible errors.

12.2 Comments

12.2.1 EMC Directive

Hart Scientific’s equipment has been tested to meet the European Electromagnetic Compatibility Directive (EMC Directive, 89/336/EEC). The Declaration of Conformity for your instrument lists the specific standards to which the unit was tested.

12.2.2 Low Voltage Directive (Safety)

In order to comply with the European Low Voltage Directive (73/23/EEC), Hart Scientific equipment has been designed to meet the IEC 1010-1 (EN 61010-1) and IEC 1010-2-010 (EN 61010-2-010) standards.