

719PRO Pressure Calibrator

Quick Reference Guide

Warning

To prevent possible electrical shock, fire, or personal injury, read the "719PRO Safety Sheet" before you use this Product.

Go to www.fluke.com to register your product, download manuals, and find more information.

Upper Channel

Setup

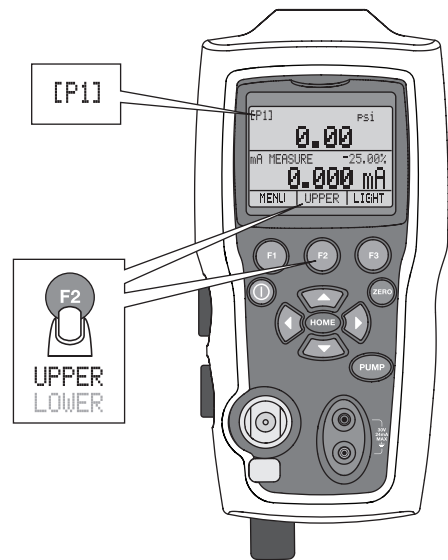

Unit Select

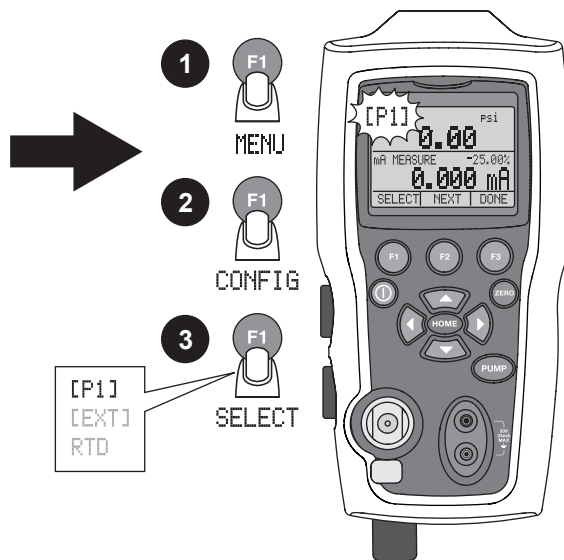

External Connection

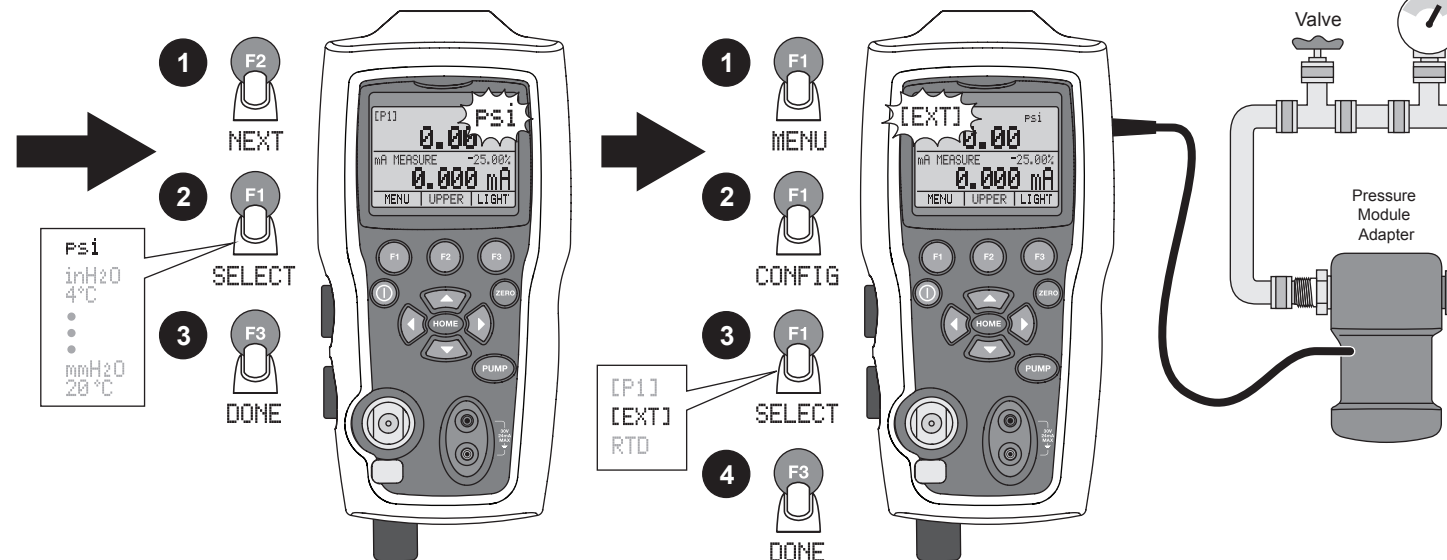

Display

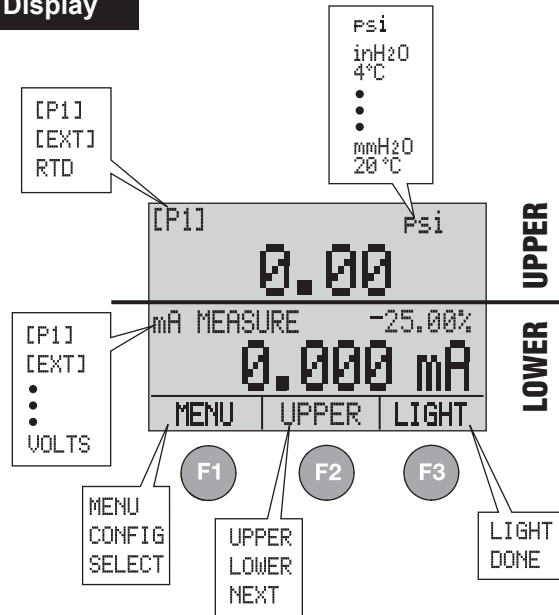

Lower Channel

Measure mA

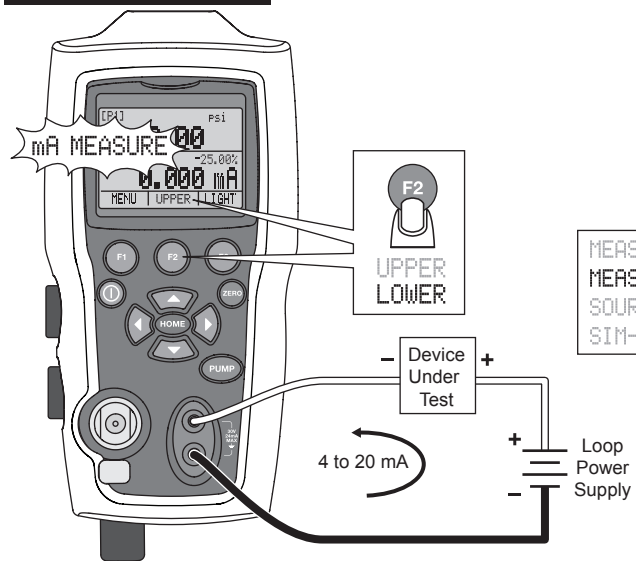

Measure mA 24 V Loop

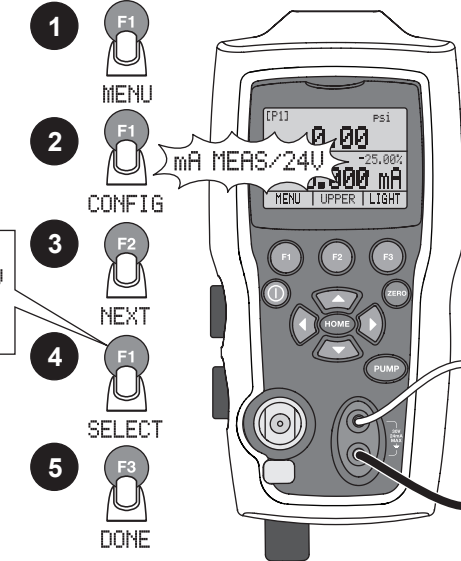

Source mA

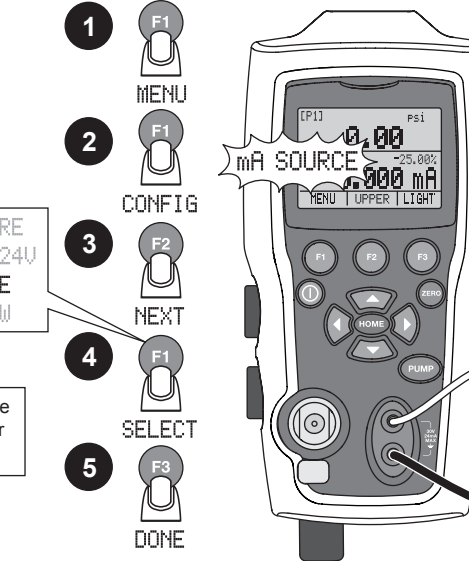

mA Simulate

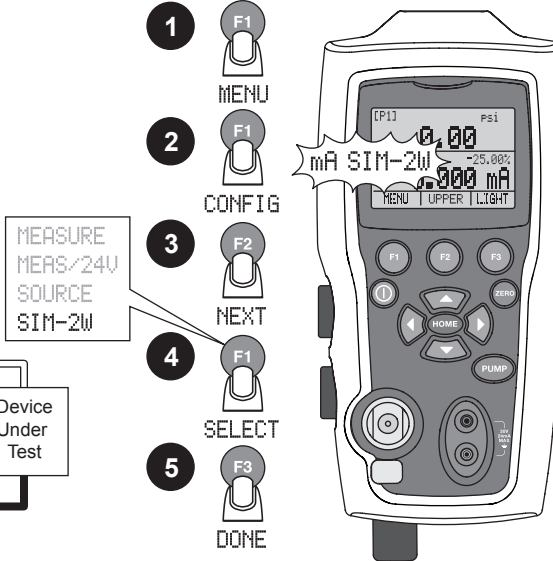

Lower Channel

Measure Volts

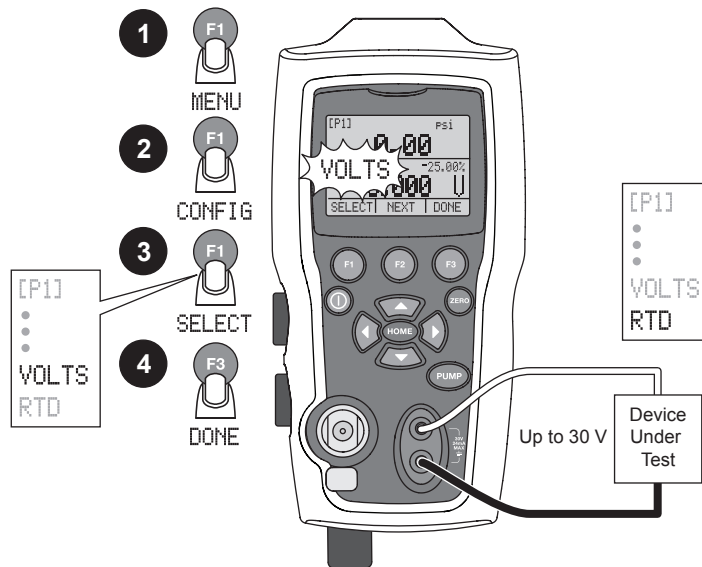

Measure RTD

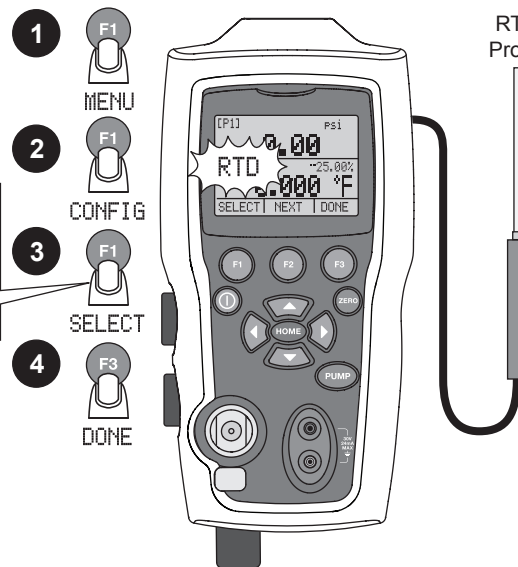

Temperature Units

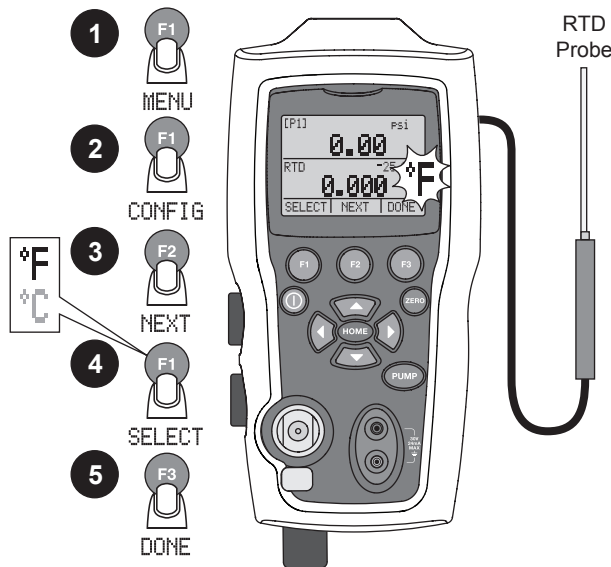

Batteries

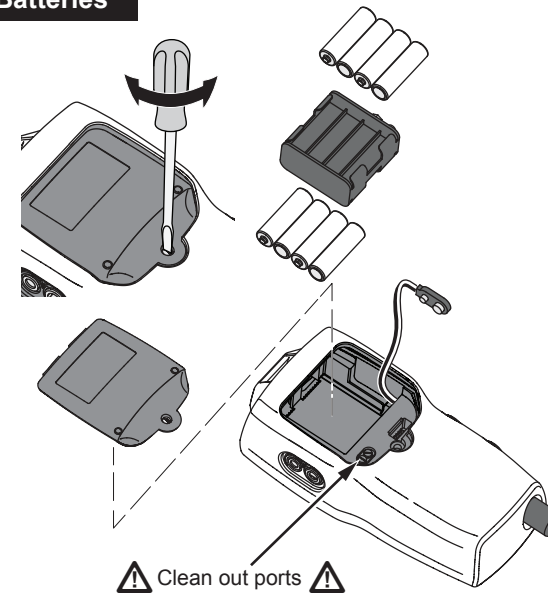

RS-232/USB

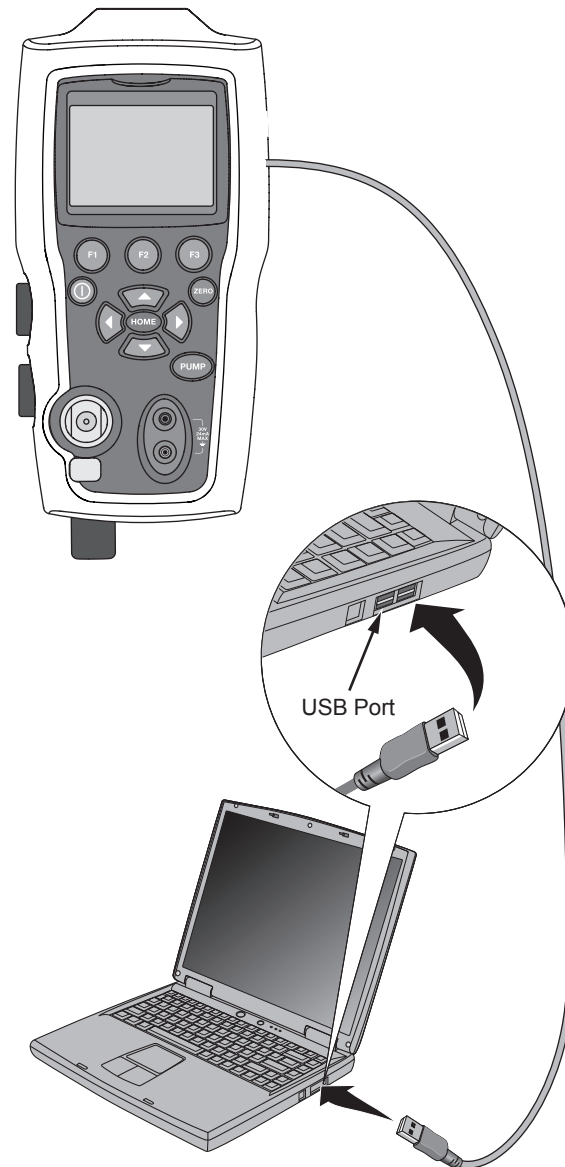

Menu Options

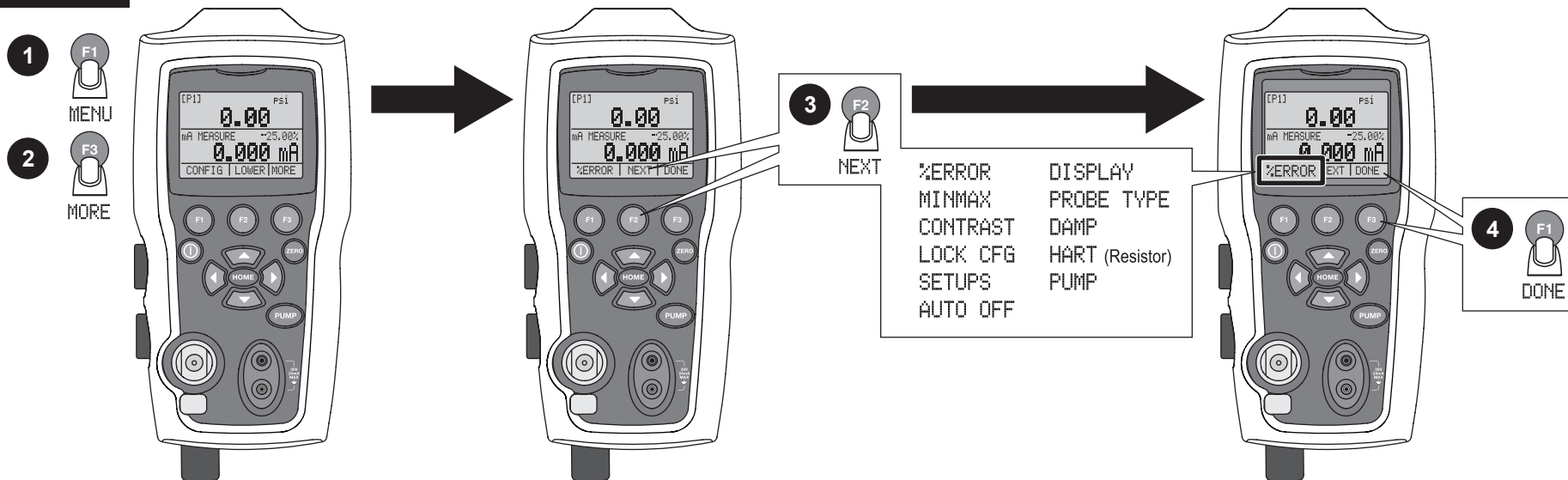

Set Language

